



Apple

2024 MOUNTING SOLUTIONS



Field Service · Healthcare · Manufacturing · Public Safety · Retail · Transportation · Warehouse

National Products, Inc. | RAM® Mounts



The Industry Standard

For over 30 years, National Products, Inc. has supplied the most rugged and connective mobile device mounting systems on the planet. With the globally recognized RAM® Mounts, award-winning GDS® Tech™ and IntelliSkin® product lines, NPI's mission to bring world-class mounting solutions to real-world applications have become essential to success in all industries—we are the industry standard.





Contents

IntelliSkin® & GDS® Tech™

- 4 How it Works: IntelliSkin® & GDS® Tech™
- 6 GDS® Uni-Conn™ Docks
- 8 IntelliSkin® Thin-Case™
- 10 Modular Components & Input Devices
- 12 GDS® Ergo™

Industries

- 14 GDS® Tech™ for Healthcare
- 16 EFB Solutions for Aviation
- 18 Material Handling
- 20 Transportation Solutions

Latest Models

- 22 iPhone 15 Series
- 24 IntelliSkin® and GDS® Tech™ for iPhone 15
- 26 iPad Pro & Air Series
- 28 IntelliSkin® & GDS® Tech™ for iPad Pro & Air Series
- 32 iPad Series
- 34 IntelliSkin® & GDS® Tech™ for iPad Series
- 38 iPad Mini 6
- 40 IntelliSkin® & GDS® Tech™ for iPad mini 6
- 44 Apple MagSafe® Adapter
- 46 Build Your Custom iPhone Mount
- 48 RAM® Low Profile Mounts
- 50 RAM® Double Ball Mounts for iPads
- 52 RAM® No-Drill™ Mounts

Accessories

- 54 iPad & Keyboard Solutions
- 56 Temperature Control Products
- 58 RAM® Vibe-Safe™
- 60 RAM® Universal Hand-Stand™
- 62 Accessibility Solutions

Compatibility

- 64 iPhone & iPad Compatibility
- 66 GDS® Uni-Conn™ Compatibility
- 68 Hardwire Chargers

How it Works

IntelliSkin® & GDS® Tech™

The GDS® Tech™ platform provides protection, charging, and data sync capabilities across a wide range of electronic devices, making it a perfect solution for fleet deployment. With GDS® Compatible™ IntelliSkin® protective sleeves, GDS® Docks™, and GDS® Ecosystem™ accessories, simplify the process of scaling and upgrading devices while taking advantage of a standardized charging and data transfer ecosystem.



Positioning Markers

ensure consistent connection

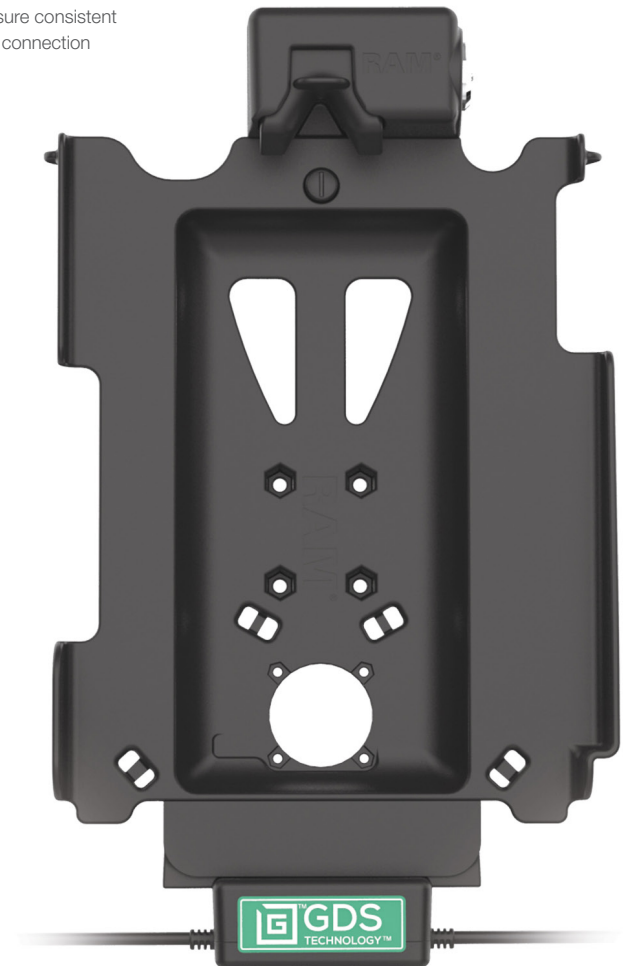

Pogo Pins and Pads

enable an effortless, fumble-free docking experience

Types of IntelliSkin®



IntelliSkin® Next Gen



IntelliSkin® Thin-Case™



IntelliSkin® for iPhone

GDS® Docks for Tablets



GDS® Tough-Dock™



GDS® Uni-Conn™



GDS® Desktop Docks

GDS® Docks for Phones



GDS® Phone Dock



GDS® Desktop Docks



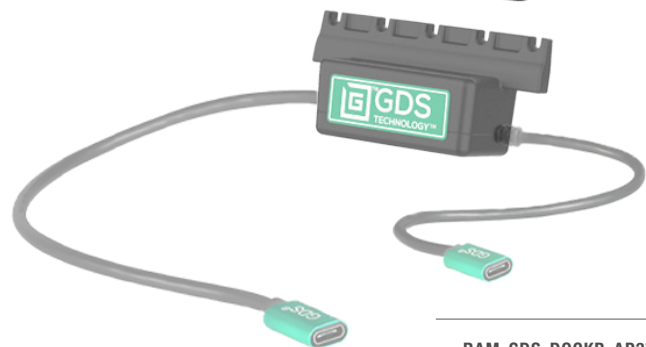

Top Latches



RAM-GDS-DOCKH2U
GDS® Tough-Dock™ & Cool-Dock™ Top Latch



RAM-GDS-DOCKLH2U
GDS® Tough-Dock™ & Cool-Dock™ Locking Top Latch



RAM-GDS-DOCKB-AP32U
GDS® Tough-Dock™ Body for Apple iPad Air 5 & iPad Pro 11" 1st- 4th Gen

RAM-GDS-DOCKB-AP37U
GDS® Tough-Dock™ Body for Apple iPad Pro 12.9" 6th Gen

INTELLISKIN™ & GDS® TECH™
Modular Components

The modularity of GDS® Tough-Docks™ provides the highest quality and most cost-effective solutions for tablets, including inevitable future device upgrades. With interchangeable dock latches and bases, it's easy to modify existing mounting systems without breaking the bank on an entirely new system.

Docking Cups



RAM-GDS-DOCK-V10PDU
GDS® Power + Single USB-A Dock Cup for IntelliSkin® Next Gen Tablets



RAM-GDS-DOCK-V10C-CAU
GDS® Power + USB-C & USB-A Data Dock Cup for IntelliSkin®

DOCKING CUPS	PERIPHERAL PORTS
RAM-GDS-DOCK-V10PU	—
RAM-GDS-DOCK-V10PDU	(1) USB-A
RAM-GDS-DOCK-V10PD2U	(2) USB-A
RAM-GDS-DOCK-V10C-CU	(1) USB-C
RAM-GDS-DOCK-V10C-CAU	(1) USB-A, (1) USB-C
RAM-GDS-DOCK-V10C-RJ45AU	(1) USB-A, (1) Ethernet

INTELLISKIN™ & GDS® TECH™

Input Devices

GDS® Tech™ supports peripheral enablement and allow users to connect peripherals directly to their device. With a variety of accessories available in the GDS® Ecosystem™, you can easily swap as the needs of your company grow.

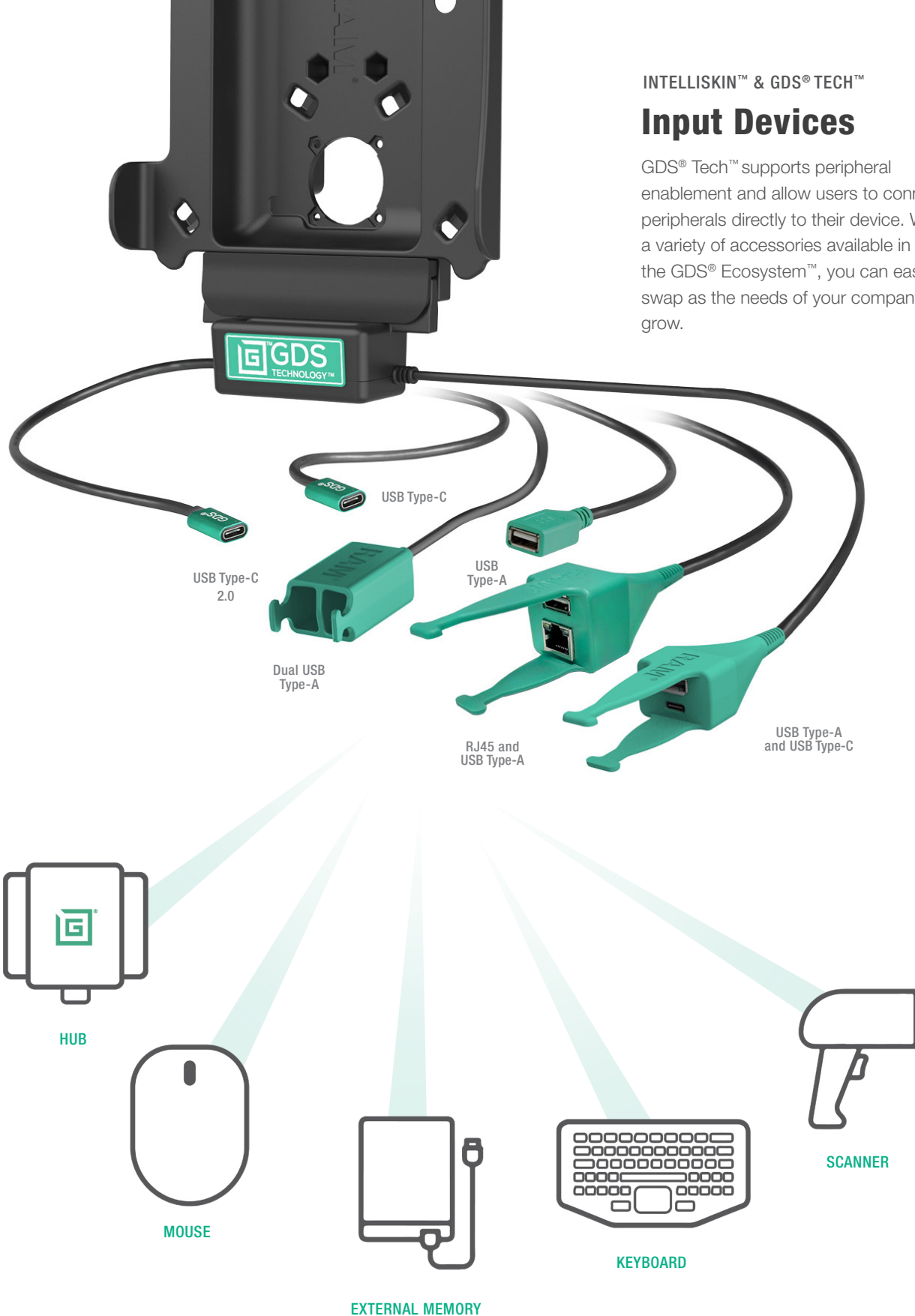

GDS® Uni-Conn™ Docks **One Dock to Connect Them All™**

GDS® Uni-Conn™ is the newest innovation from RAM® Mounts that features a universal, snap-in docking system. This platform eliminates the hassle of costly device upgrades, relying on the IntelliSkin®-wrapped device and the GDS® Uni-Conn™ adapter as the connection point to the revolutionary, low-profile docking station. Not only does this system make upgrading easy, but it simplifies the docking process, too. When considering your next device upgrade, there truly is only One Dock to Connect Them All™.

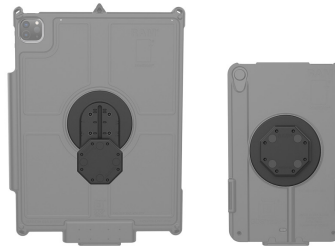

GDS® Uni-Conn™ Adapters for IntelliSkin®

Unlock the potential of GDS® Uni-Conn™ by installing the adjustable button adapter (**RAM-GDS-U1AU**) or standard adapter (**RAM-GDS-U1U**) to the back of your IntelliSkin®.



Seamless Device Upgrades for the Future

Each IntelliSkin® is designed with the alignment point at the same height to connect with one universal docking station. When the time comes to upgrade devices in your fleet, a new IntelliSkin® is all that is needed. *NOTE: failure to install dock lever stop will void warranty.*



Spring Loaded for Backwards Compatibility

For most IntelliSkin®-wrapped tablets outside of the listed compatible devices, a spring loaded version of the GDS® Uni-Conn™ dock is available so you can implement this solution ahead of your next device upgrade.

IntelliSkin®-Wrapped Device Compatibility for GDS® Uni-Conn™ Docks

These IntelliSkin® are compatible with the GDS® Uni-Conn™ Docking System

IntelliSkin® Next Gen



iPad mini 6
pg. 40



iPad 10th Gen
pg. 34



iPad Air 5 & Pro 11"
pg. 28



iPad Pro 12.9"
pg. 28

IntelliSkin® Thin-Case™



iPad mini 6
pg. 41



iPad 10th Gen
pg. 35

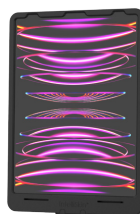

iPad Pro 12.9"
pg. 29

Compatible Accessories



RAM-GDS-U1HSU
GDS® Hand Strap with
Uni-Conn™ Adapter



LOCKING OPTIONS
COMING SOON



IntelliSkin® Thin-Case™

Introducing a new style of IntelliSkin®, the IntelliSkin® Thin-Case™. This sleek, low-profile design fully encloses your device, keeping it safe from daily wear and tear. The IntelliSkin® Thin-Case™ is easy to sanitize, making it an ideal solution for medical and retail industries. Available in two variants with two different mounting ecosystems—the standard IntelliSkin® Thin-Case™ and the IntelliSkin® Thin-Case™ with Rear Pogo Pads.



IntelliSkin® Thin-Case™

Standard Distinctive D Shape™ bottom connector, ideal for vehicle and desktop docks.



IntelliSkin® Thin-Case™ with Rear Pogo Pads

Internal USB-C connector plugs into the devices and provides power via the pogo pads integrated into the GDS® Uni-Conn™ adapter. This form factor of GDS® Tech™ is Ideal for wall mounted solutions and kiosks.



D Shape™ Compatible Solutions



GDS® Uni-Conn™ Dock



GDS® Uni-Conn™ Spring Loaded Dock



GDS® Uni-Conn™ Wall Dock

Rear Pogo Pad Compatible Solutions



GDS® Uni-Conn™ Powered Snap-In Dock

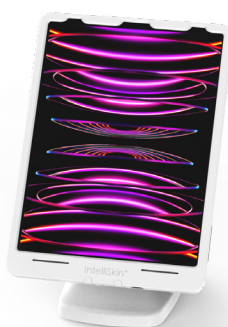

GDS® Powered Kiosk Dock



GDS® Powered Wall Dock

IntelliSkin® Thin-Case™ Accessories



GDS® Shoulder Strap Swivel Fastener for IntelliSkin® Thin-Case™



GDS® Hand Strap for IntelliSkin® Thin-Case™



SEEN IN THIS PHOTO:

RAM-GDS-SS1U

GDS® Shoulder Strap
Accessory

INTELLISKIN™ & GDS® TECH™

GDS® Ergo™

Enable your iPad for field use with these GDS® Ergo™ accessories. The GDS® Hand-Stand™ is a combination hand strap and kickstand that allows you to take your device from the warehouse to the office—and everywhere in between. With the shoulder strap accessory, quickly attach various IntelliSkin® sleeves to comfortably carry your iPad.



RAM-GDS-ROTO2U
GDS® Roto-Mag™ 2-in-1
Accessory with Grip Handle,
Hand Strap & Magnets



RAM-GDS-HS1U
GDS® Hand-Stand™ Hand Strap
and Kickstand for Tablets

MAGNETIC VERSION

RAM-GDS-HS1MU
GDS® Hand-Stand™ Magnetic Hand Strap
and Kickstand for Tablets



RAM-GDS-HS4U
GDS® Hand Strap for Phones
with IntelliSkin® or RAM® Skin™



RAM-GDS-HS4MU
GDS® Magnetic Hand-Strap
for Phones with IntelliSkin® or
RAM® Skin™



Light Gray Collection



Custom Color Options

Interested in custom colored products for your business?
Contact support@rammount.com



INDUSTRIES

EFB Solutions for Aviation

With RAM® Mounts in the cockpit, safely secure your iPad mini 6 with or without a case. Engineered to withstand up to 50 g's of force, the RAM® double ball and socket system allows for near-infinite adjustability so your iPad can be placed exactly where it's needed.

RAM-BM-L1-SB1-TAB2U

RAM® Tab-Tite™ with
Kneeboard Mount



Designed to keep tablet
at an angle to avoid sun
glare while in flight



The yoke clamp base
will fit rails in diameter
from 0.625" to a
maximum of 1.25"



RAM-B-121-AP36U

RAM® EZ-Roll'r™ Cradle
with Yoke Clamp Mount





SKUS	MOUNT NAME
RAM-B-121-AP36U	RAM® EZ-Roll'r™ Cradle with Yoke Clamp Mount
RAM-BM-L1-SB1-TAB2U	RAM® Tab-Tite™ with Kneeboard Mount
RAM-B-166-AP36U	RAM® Twist-Lock™ Suction Cup
RAM-BM-L1-SB1-TAB12U	RAM® Tab-Tite™ with Kneeboard Mount
RAM-B-121-TAB12U	RAM® Tab-Tite™ Yoke Clamp Mount with Heavy Duty Cases
RAM-B-166-TAB12U	RAM® Twist-Lock™ Suction Cup with Heavy Duty Cases



Holds strong against any windshield or non-porous surface

RAM-B-166-AP36U
RAM® Twist-Lock™ Suction Cup



INDUSTRIES

Transportation

For the last few decades, RAM® Mounts has collaborated with the industry's best innovators to build the future of mobility. The key to a mobile workforce combines device, software, and docking solution. Every day our engineering teams look for ways to optimize product performance to seamlessly integrate into one another, making the lives of drivers all around the world easier, and business logistics scalable. That's why RAM® offers turnkey, rugged, cost-effective mounting solutions for ELD compliance. Depending on what device you are deploying, RAM® will either have the right solution ready to go or custom-build the right kit for you. Take advantage of upgrades like peripheral support, add-on accessories, and the award-winning GDS® Tech™ for connective longevity and reliability.

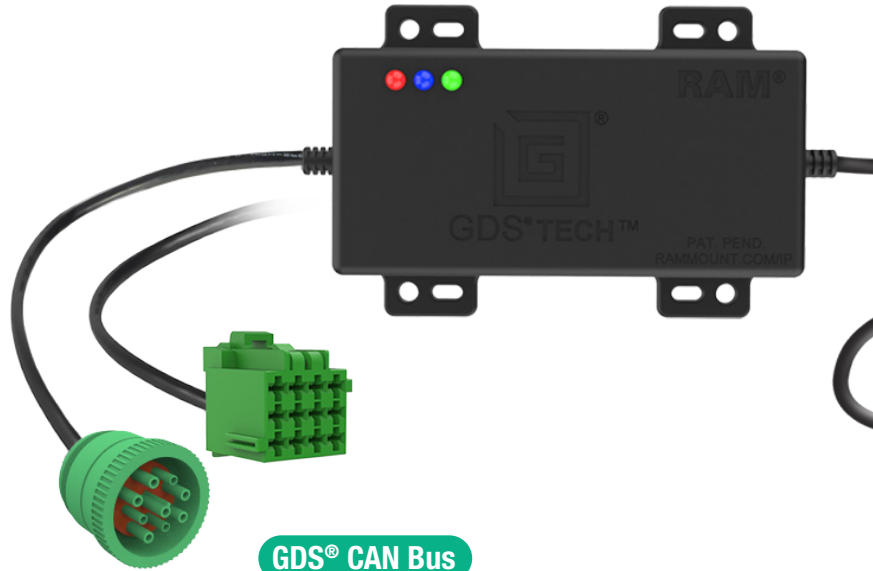

GDS® CAN Bus

Allows users to bypass the need for intermediate telematics units and subscription services and employ third-party software or develop their own applications, providing unparalleled flexibility and control over vehicle data.

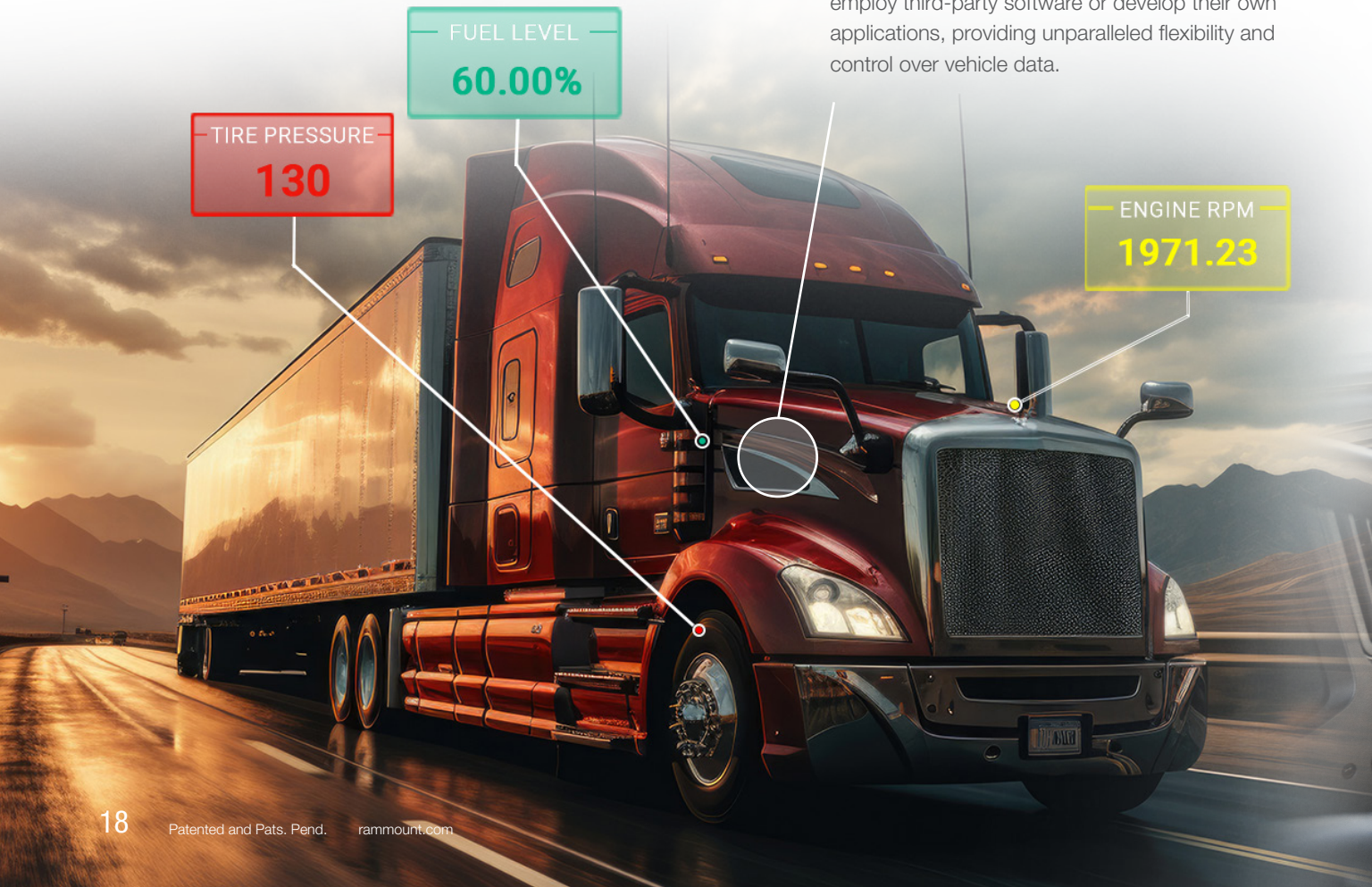

GDS® Ecosystem™

Effortlessly mount, charge, and stay informed with the GDS® Tech™ Ecosystem™, providing drivers with real-time data for a connected journey.



Unlock the power of seamless data transfer and Power Delivery fast charging with GDS® CAN Bus technology

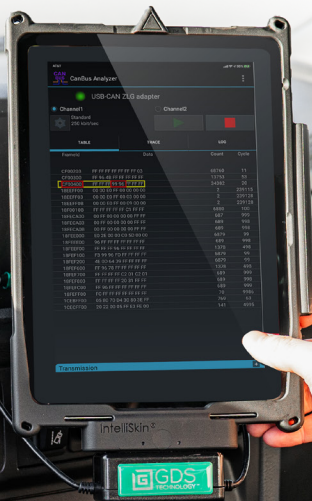

RAM-GDS-U1-AP40-KIT1
GDS® Uni-Conn™ Vehicle Bundle for Apple iPad 10th Gen

INDUSTRIES

Material Handling

Distracted driving causes accidents. Keep your team's hands free and on the steering wheel while they operate heavy machinery with help from RAM® Mounts. Our forklift solutions keep the devices in view without obstructing the driver's field of vision.



RAM-GDS-DOCKL-AP32CU
Locking GDS® Tough-Dock™ with USB-C 3.1 for iPad 10, Air 5 & Pro 11"



4" clamping base for posts

D size ball mount supports the weight of tablet and keyboard

Slotted holes on backing plate allow for cable retention

Keyboard mount can be angled for optimal user wrist comfort



RAM-KB2-USB
GDS® Keyboard™ with Track pad

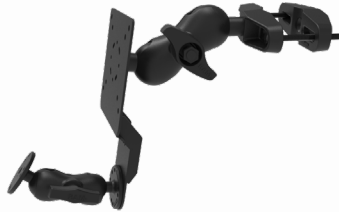

RAM-D-247-C-254-DIS1U
RAM® Universal Forklift Post Mount with Round Plate & Accessory Option

Safety Standards

RAM® Mounts makes it easier to comply with local, federal, and international forklift safety standards to keep your workers safe while on the job.



RAM-E-101-335

RAM® Forklift Overhead Guard Double Ball Mount with Large Round Plate



RAM-GDS-SKIN-AP32-NG

IntelliSkin® Next Gen for iPad 10, Air 5 & Pro 11" 1st- 4th Gen



RAM-101U-247

RAM® Universal Post Clamp Mount with Round Plate - C Size Medium Arm



4" clamping base for posts

C size ball mount supports the weight of tablet

LATEST MODELS

iPhone 15 Series

For the newest iPhone models, RAM® Mounts has multiple phone holder options from form-fitting designs to universal solutions. If you're rocking an iPhone without a case, our form-fit cradles for iPhone 15 models fit perfectly, are low cost, and low profile. For all other situations, our RAM® X-Grip® and RAM® Quick-Grip™ holders are designed to hold your iPhone 15 with any case on it.



RAM-HOL-AP38-1U
Fits iPhone 15 Pro



RAM-HOL-PD4-238AU
Fits entire iPhone 15 Series



RAM-HOL-UN7BU
Fits iPhone 15 Pro

SKUS	HOLDER TYPE	COMPATIBILITY
RAM-HOL-UN10BU	RAM® X-Grip®	Fits iPhone 15, iPhone 15+, iPhone 15 Pro Max
RAM-HOL-UN7BU	RAM® X-Grip®	Fits iPhone 15 Pro
RAM-HOL-PD4-238AU	RAM® Quick-Grip™	Fits entire iPhone 15 Series
RAM-HOL-AP38U	Form-Fit	Fits iPhone 15
RAM-HOL-AP38-1U	Form-Fit	Fits iPhone 15 Pro
RAM-HOL-AP39U	Form-Fit	Fits iPhone 15+
RAM-HOL-AP39-1U	Form-Fit	Fits iPhone Pro Max



Form-Fit



Camera Exposed



Price



Without Case



One-Handed Operation



No Assembly



RAM® Quick-Grip®



Camera Blocked
Depending on Model



Price



With or Without Case



One-Handed Operation



Assembly Required



RAM® X-Grip®



Camera Exposed
*Without Tether



Price



With or Without Case



Two-Handed Operation



No Assembly

LATEST MODELS

IntelliSkin® and GDS® Docks™ for iPhone 15

Unlock the GDS® Ecosystem™ for iPhones with IntelliSkin®. Each rugged case is custom-molded to the specific device model for a seamless fit and features an integrated USB-C connector with external pogo pads to protect the port from daily wear and tear. Keep your fleet of devices connected and charged with a variety of desktop and vehicle docks to choose from.

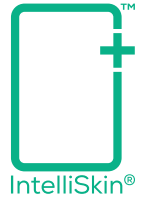

Pogo Pads protect device ports from constant plugging and unplugging, flat for easy cleaning



Included Steel Belt Clip Attachment

D-Shaped Platform ensures seamless fit between GDS® Docks™ and IntelliSkin®



RAM-GDS-SKIN-AP41
IntelliSkin® for iPhone 15



RAM-GDS-SKIN-AP43
IntelliSkin® for iPhone 15+



RAM-GDS-SKIN-AP42
IntelliSkin® for iPhone 15 Pro



RAM-GDS-SKIN-AP44
IntelliSkin® for iPhone 15 Pro Max

GDS® Docks™ for iPhone

Keep your fleet of devices charged and connected in-vehicle with the rugged, reliable GDS® Dock™.



USB-C 3.1



LOCKING

RAM-GDS-DOCKL-V3CU

GDS® Locking Vehicle Phone Dock with USB Type-C 3.1 for IntelliSkin®



NON-LOCKING

USB-C 3.1

RAM-GDS-DOCK-V1CU

GDS® Vehicle Phone Dock with USB Type-C 3.1 for IntelliSkin® Products



LOCKING

USB-C 2.0

RAM-GDS-DOCKL-V3CPU

GDS® Locking Vehicle Phone Dock with USB Type-C 2.0 for IntelliSkin®



NON-LOCKING

USB-C 2.0

RAM-GDS-DOCK-V1CPU

GDS® Vehicle Phone Dock with USB Type-C 2.0 for IntelliSkin® Products



LATEST MODELS

iPad Pro & Air Series

The Apple iPad is a multifaceted device collection that is used by individuals and professionals alike. This versatile piece of equipment deserves an equally versatile mounting solution, and that's where RAM® Mounts comes in. From Form-Fit holders that are custom-molded to the device's dimensions to universal solutions that fit a wide range of device sizes, easily customize your iPad's mounting solution to do exactly what you need it to.

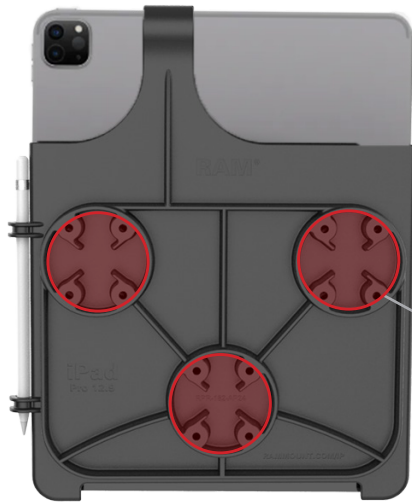
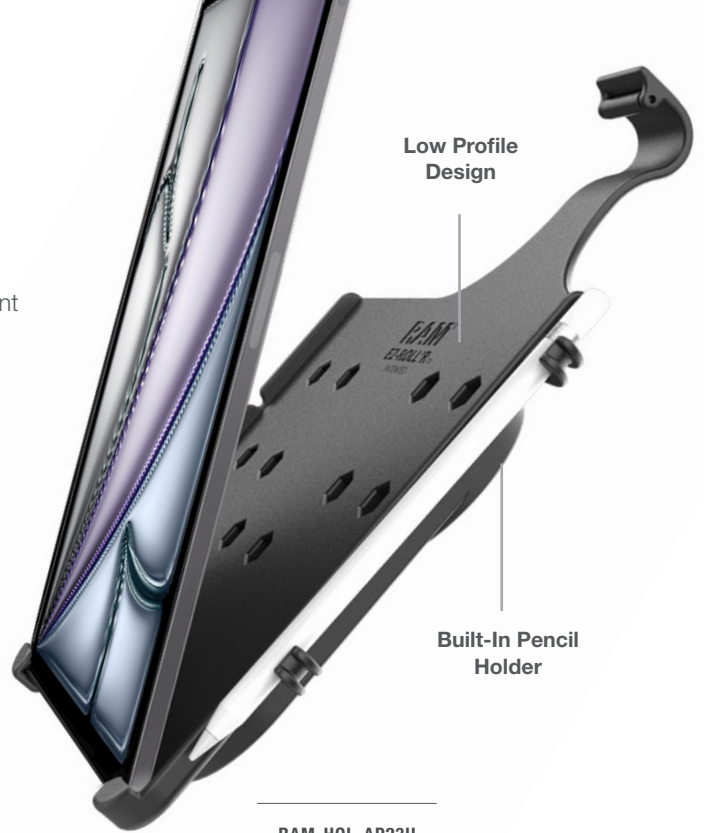

RAM-HOL-AP23U

Fits iPad Air 11" (M2), Pro 11" (M4), Air 4 & Air 5 Without Case



RAM-HOL-UN9U

Fits iPad Pro 11", Air 11" (M2), Air 4 & Air 5 With or Without Case

SKUS	COMPATIBILITY
RAM-HOL-AP23U	iPad Air 11" (M2), Air 4 & Air 5 Without Case
RAM-HOL-UN11U	iPad Air & Pro 13", iPad Pro 12.9"
RAM-HOL-TAB17U	iPad Pro 11", Air 4 & Air 5 With Case
RAM-HOL-AP23CLU	iPad Pro 11", Air 4 & Air 5 Without Case
RAM-HOL-TAB3U	iPad Pro 11", Air 4 & Air 5 Without Case
RAM-HOL-AP23KLU	iPad Pro 11", Air 4 & Air 5 Without Case
RAM-HOL-TABL17U	iPad Pro 11", Air 4 & Air 5 With Case
RAM-HOL-UN9U	iPad Pro 11", Air 11" (M2), Air 4 & Air 5 With or Without Case
RAM-HOL-AP24U	iPad Pro 13" & iPad Air 13"
RAM-HOL-AP24-1U	iPad Pro 13" & iPad Air 13"
RAM-HOL-TAB20U	iPad Pro 11" (M4) & Air 11" (M2) With Case
RAM-HOL-TABL20U	iPad Pro 11" (M4) & Air 11" (M2) With Case



Form-Fit



Camera Exposed



Price



Fits iPad Without Case



Low Profile Design

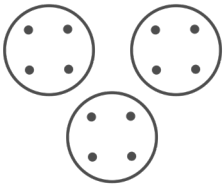

(3) 4-Hole AMPS Patterns



RAM® Tab-Tite™ & Tab-Lock™



Camera Blocked Depending on Model



Price



iPad Fits With or Without Case



Locking Version Available



(1) 4-Hole AMPS Pattern



RAM® X-Grip®



Camera Exposed *Without Tether



Price



Fits iPad With or Without Case

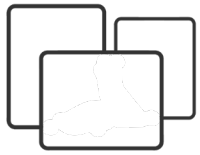

Most Universal Solution

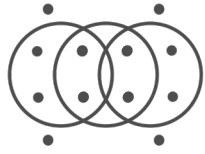

(3) 4-Hole AMPS Patterns
(1) 75x75 VESA Pattern

LATEST MODELS

IntelliSkin® for iPad Pro & Air

Take your iPad's efficiency to the next level with an IntelliSkin®. This device case features an integrated USB-C connector with external pogo pads, unlocking the GDS® Ecosystem™ of vehicle docks, desktop docks, peripheral devices, and ergonomic accessories.

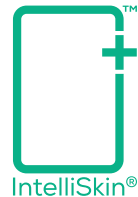

IntelliSkin® Next Gen

Features



RAM-GDS-SKIN-AP32-NG

IntelliSkin® Next Gen for Apple iPad Air 5, 4 & iPad Pro 11" 1st - 4th Gen

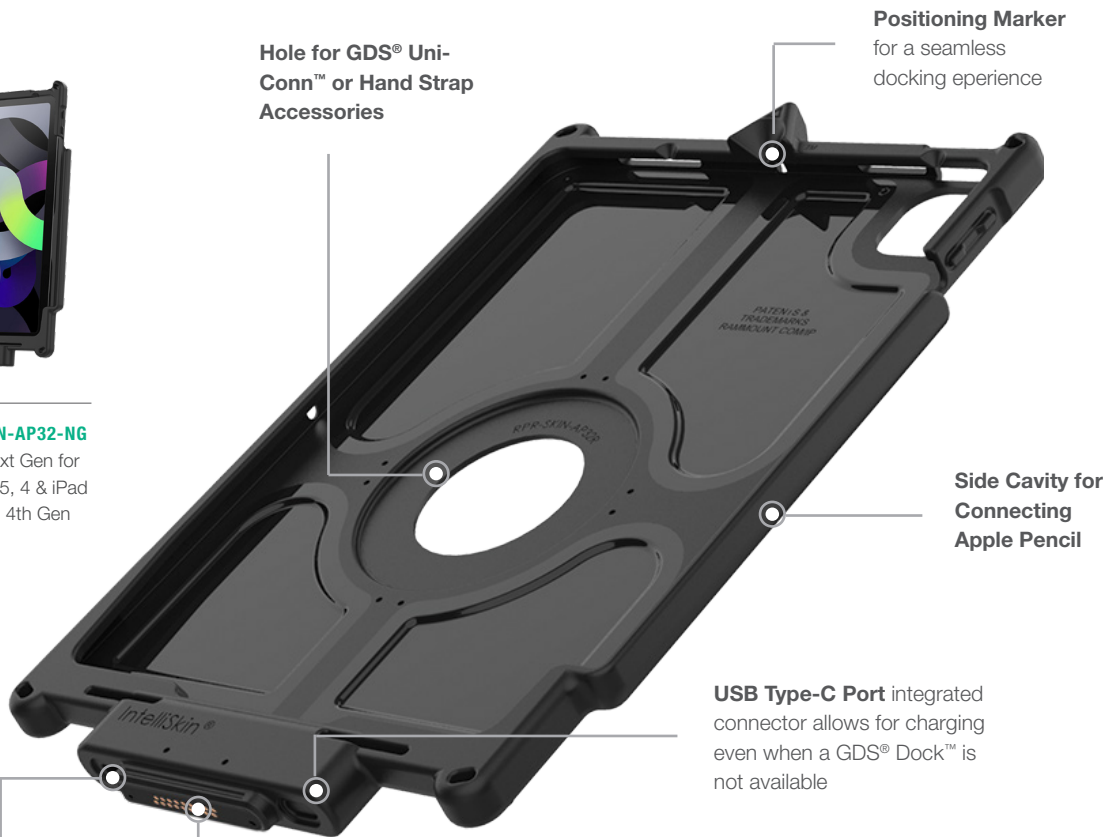

RAM-GDS-SKIN-AP37-NG

IntelliSkin® Next Gen for Apple iPad Pro 12.9" 3rd-6th Gen



RAM-GDS-SKIN-AP32-NG-LED

IntelliSkin® Next Gen with LED for Apple iPad Air 5, 4 & iPad Pro 11" 1st - 4th Gen

IntelliSkin® Thin-Case™

Features



2-PIECE ENCLOSURE
Ensures a reliable and protected connection, providing a seamless fit



ULTRA SLIM DESIGN
A low profile solution that maintains durability in a variety of environments



POLYCARBONATE HARD PLASTIC SHELL
Prevents flex at the connection point between case and device

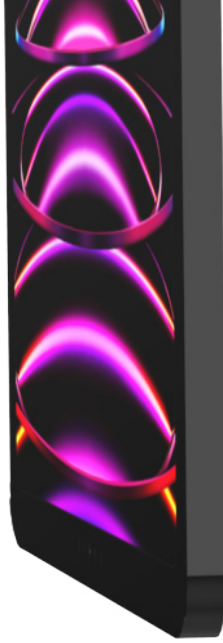

TWO DISTINCT CONNECTION OPTIONS

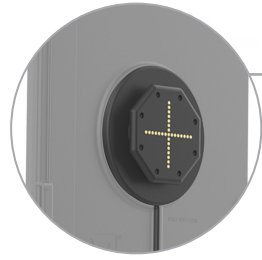

Rear Pogo Pads
compatible with all Uni-Conn™ powered docks, pg. 9

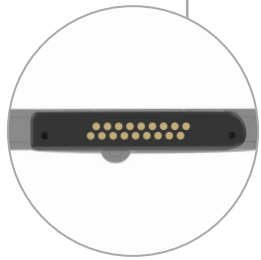

D Shape™ Bottom Connector
compatible with GDS® Ecosystem™, ideal for vehicle and desktop docks

Built-in hand strap connection point
* Accessory sold separately



Rear Pogo Pads

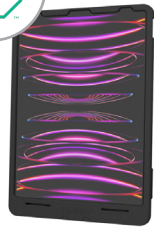

RAM-GDS-SKIN-AP37-TCB
IntelliSkin® Thin Case™ for Apple iPad Pro 12.9" 3rd-6th Gen



D Shape™ Bottom Connector

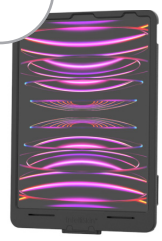

RAM-GDS-SKIN-AP37-TCD
IntelliSkin® Thin Case™ for Apple iPad Pro 12.9" 3rd-6th Gen

LATEST MODELS

GDS® Tough-Docks™ for iPad Pro & Air

The GDS® Tough-Dock™ is a rugged, modular frame for IntelliSkin®-wrapped devices that are highly customizable to your business needs. These docks are key to the GDS® Reach™ experience—standardized charging, data transfer, and simplified scaling.



Supports Temperature Control Accessories
See pg. 56

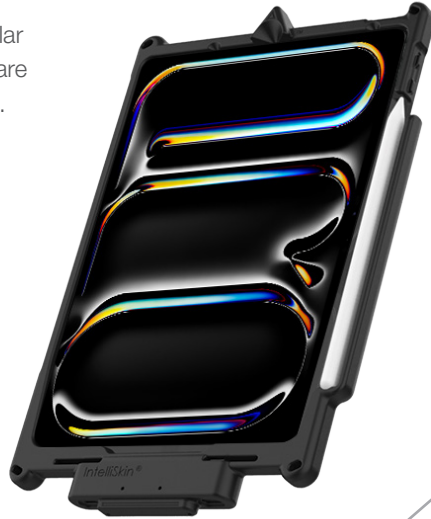

Built-In Cavity Supports Ergonomic Accessories

Locking & Non-Locking Options



AMPS Mounting Pattern

USB-C Connection Supports Power Delivery

Peripheral Support

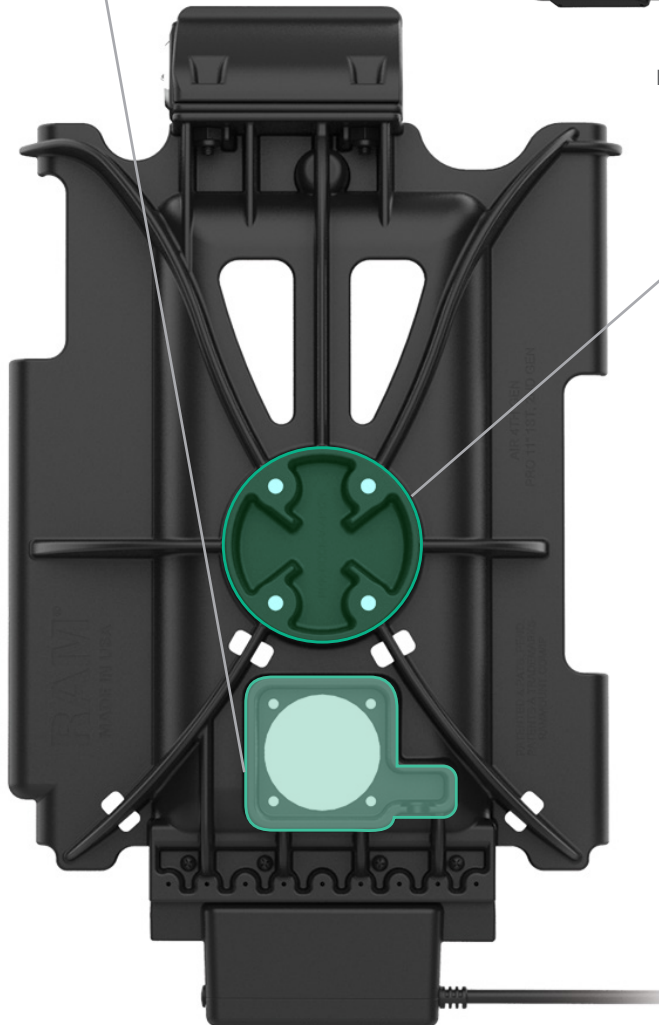

For iPad Pro 12.9" 6th Gen

PART ID	POWER	KEY LOCKING	PERIPHERALS
RAM-GDS-DOCK-AP37CPU	USB-C 2.0		
RAM-GDS-DOCKL-AP37CPU	USB-C 2.0	•	
RAM-GDS-DOCK-AP37CD2U	USB-C 2.0		(2) USB-A

For iPad Pro 11", Air 4 & Air 5

PART ID	POWER	KEY LOCKING	PERIPHERALS
RAM-GDS-DOCK-AP32CPU	USB-C 2.0		
RAM-GDS-DOCKL-AP32CPU	USB-C 2.0	•	
RAM-GDS-DOCK-AP32CDU	USB-C 2.0		(1) USB-A
RAM-GDS-DOCKL-AP32CDU	USB-C 2.0	•	(1) USB-A
RAM-GDS-DOCKL-AP32C-CU	USB-C 2.0	•	(1) USB-C
RAM-GDS-DOCK-AP32CD2U	USB-C 2.0		(2) USB-A
RAM-GDS-DOCKL-AP32CD2U	USB-C 2.0	•	(2) USB-A
RAM-GDS-DOCK-AP32C-CAU	USB-C 2.0		USB-A & USB-C
RAM-GDS-DOCK-AP32CU	USB-C 3.1		
RAM-GDS-DOCKL-AP32CU	USB-C 3.1	•	

LATEST MODELS

GDS® Uni-Conn™ Docks for iPad Pro & Air

The GDS® Uni-Conn™ is a universal snap-in docking system. All that is needed is an attachable button adapter and an IntelliSkin® protective case to enable this revolutionary docking station—eliminating the hassle of costly device upgrades. When considering your next device upgrade, there truly is only One Dock to Connect Them All™.

Listen for "Click" noise

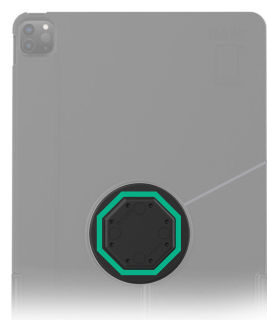
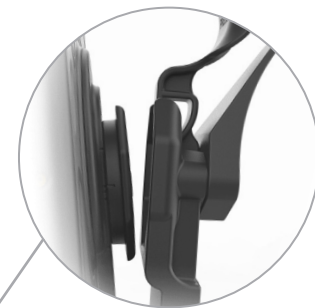

Standard Adapter
RAM-GDS-U1U
GDS® Uni-Conn™ Adapter

Enables snap-in compatibility with IntelliSkin® for newer device models.

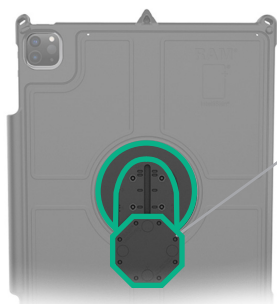

Adjustable Adapter
RAM-GDS-U1AU
GDS® Uni-Conn™ Adjustable Adapter

Enables snap-in compatibility with IntelliSkin® for all device models.



- 1 Set the IntelliSkin®-wrapped device into the bottom connector of the dock.
- 2 Then gently push the device forward until you hear a click.

DEVICE	INTELLISKIN® PART NUMBER	STANDARD GDS® UNI-CONN™ ADAPTER	ADJUSTABLE ADAPTER SETTING POSITION ARROW ORIENTATION	NON-LOCKING SPRING LOADED	LOCKING
iPad Pro 11", Air 4 & 5	RAM-GDS-SKIN-AP32-NG		#5 ↑	•	•*
	RAM-GDS-SKIN-AP32-NG-LED		#5 ↑	•	•*
iPad Pro 12.9" 3rd - 6th Gen	RAM-GDS-SKIN-AP37-NG		#8 ↓	•*	
	RAM-GDS-SKIN-AP37-TCD	•			
	RAM-GDS-SKIN-AP37-TCB	•			



SEEN IN THIS PHOTO:

RAM-HOL-UN9U

RAM® X-Grip® Universal Holder for
9"-11" Tablets

RAM-VB-196-DB2

RAM® No-Drill™ Universal Vehicle
Floor Mount with Double Ball Mount

LATEST MODELS

iPad Series

For the Apple iPad, RAM® Mounts offers two unique styles of device holders. The RAM® X-Grip® is a beloved universal solution, fitting the widest range of devices with or without a case that will likely fit the device you upgrade to in the future. The RAM® Tab-Tite™ features unique top and bottom cups that fit a narrower set of dimensions, providing a snug and secure fit at a lower price point.



Optional support arms keep tablet secure in portrait mode and extreme environments



Handles on the back allow for convenient insertion and removal of tablet

RAM-HOL-UN9U
Fits iPad 10th Gen With or Without Case

RAM® Tab-Tite™ & RAM® Tab-Lock™

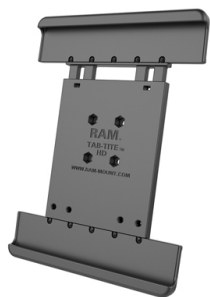

RAM-HOL-TAB26U
Fits iPad 10th Gen Without Case



RAM-HOL-TABL26U
Fits iPad 10th Gen Without Case



RAM-HOL-TAB20U
Fits iPad 10th Gen With Case



RAM-HOL-TABL20U
Fits iPad 10th Gen With Case

LATEST MODELS

IntelliSkin® for iPad 10th Gen

Take your iPad's efficiency to the next level with an IntelliSkin®. This device case features an integrated USB-C connector with external pogo pads, unlocking the GDS® Ecosystem™ of vehicle docks, desktop docks, peripheral devices, and ergonomic accessories.

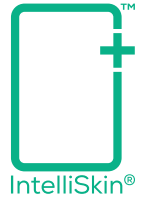

IntelliSkin® Next Gen Features

Positioning Marker
for a Seamless
Docking Experience

Hole for GDS®
Uni-Conn™ or
Hand Strap
Accessories

Side Cavity for
Connecting
Apple Pencil

USB Type-C Port
integrated connector allows
for charging even when a
GDS® Dock™ is not available

D-Shaped Platform
ensures seamless fit
between GDS® Docks™
and IntelliSkin®

Pogo Pads protect
device ports from constant
plugging and unplugging,
flat for easy cleaning



RAM-GDS-SKIN-AP40-NG
IntelliSkin® Next Gen for
Apple iPad 10th Gen

RAM-GDS-SKIN-AP40-NG-LED
IntelliSkin® Next Gen With LED
for Apple iPad 10th Gen

IntelliSkin® Thin-Case™

Features

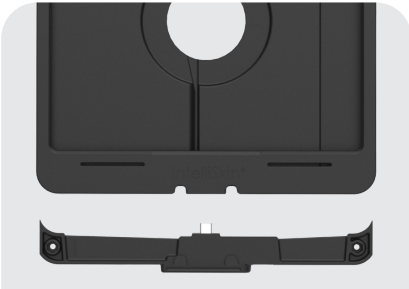

2-PIECE ENCLOSURE

Ensures a reliable and protected connection, providing a seamless fit



ULTRA SLIM DESIGN

A low profile solution that maintains durability in a variety of environments



POLYCARBONATE HARD PLASTIC SHELL

Prevents flex at the connection point between case and device



TWO DISTINCT CONNECTION OPTIONS

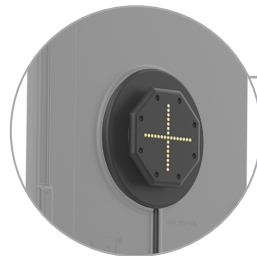

Rear Pogo Pads
compatible with all Uni-Conn™ powered docks, pg. 9

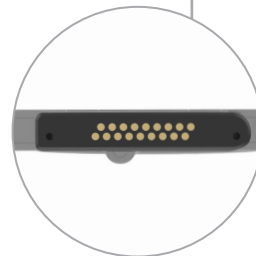

D Shape™ Bottom Connector
compatible with GDS® Ecosystem™, ideal for vehicle and desktop docks

Built-in hand strap connection point
* Accessory sold separately



Rear Pogo Pads

RAM-GDS-SKIN-AP40-TCB
IntelliSkin® Thin Case™ for Apple iPad 10th Gen



D Shape™ Bottom Connector

RAM-GDS-SKIN-AP40-TCD
IntelliSkin® Thin Case™ for Apple iPad 10th Gen

LATEST MODELS

GDS® Tough-Docks™ for iPad 10th Gen

The GDS® Tough-Dock™ is a rugged, modular frame for IntelliSkin®-wrapped devices that are highly customizable to your business needs. These docks are key to the GDS® Reach™ experience—standardized charging, data transfer, and simplified scaling.



Supports Temperature Control Accessories
See pg. 56



Built-In Cavity Supports Ergonomic



Locking & Non-Locking Options

AMPS Mounting Pattern

USB-C Connection Supports Power Delivery

Peripheral Support

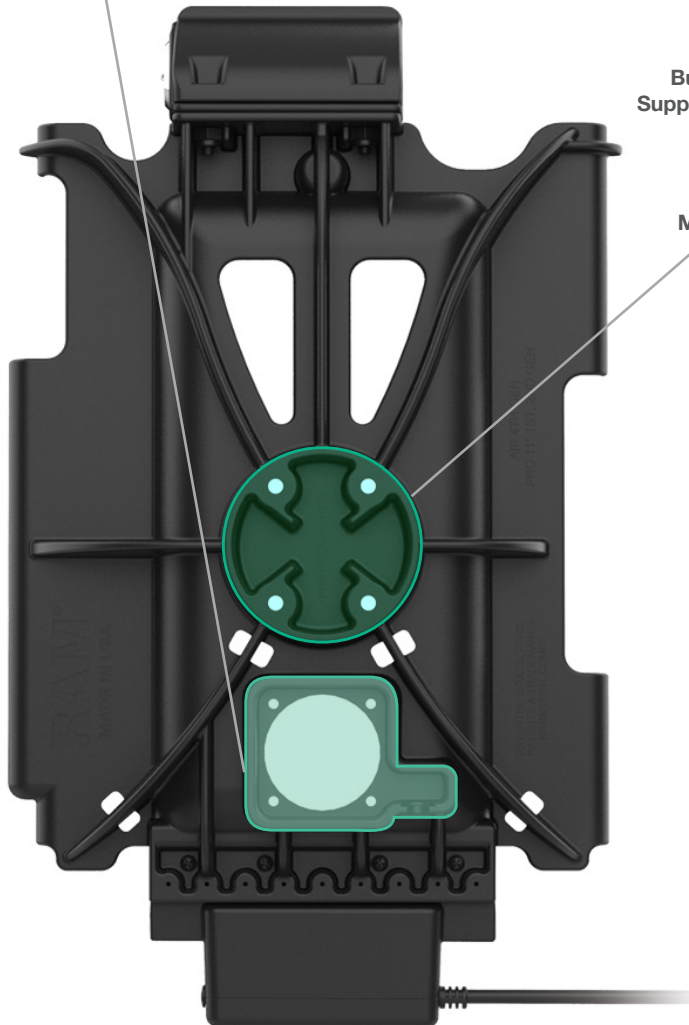

For iPad 10th Gen

PART ID	POWER	KEY LOCKING	PERIPHERALS
RAM-GDS-DOCK-AP32CPU	USB-C 2.0		
RAM-GDS-DOCKL-AP32CPU	USB-C 2.0	•	
RAM-GDS-DOCK-AP32CDU	USB-C 2.0		(1) USB-A
RAM-GDS-DOCKL-AP32CDU	USB-C 2.0	•	(1) USB-A
RAM-GDS-DOCKL-AP32C-CU	USB-C 2.0	•	(1) USB-C
RAM-GDS-DOCK-AP32CD2U	USB-C 2.0		(2) USB-A
RAM-GDS-DOCKL-AP32CD2U	USB-C 2.0	•	(2) USB-A
RAM-GDS-DOCK-AP32C-CAU	USB-C 2.0		USB-A & USB-C
RAM-GDS-DOCK-AP32CU	USB-C 3.1		
RAM-GDS-DOCKL-AP32CU	USB-C 3.1	•	

LATEST MODELS

GDS® Uni-Conn™ Docks for iPad 10th Gen

The GDS® Uni-Conn™ is a universal snap-in docking system. All that is needed is an attachable button adapter and an IntelliSkin® protective case to enable this revolutionary docking station—eliminating the hassle of costly device upgrades. When considering your next device upgrade, there truly is only One Dock to Connect Them All™.

Listen for "Click" noise



Standard Adapter
RAM-GDS-U1U
GDS® Uni-Conn™ Adapter

Enables snap-in compatibility with IntelliSkin® for newer device models.

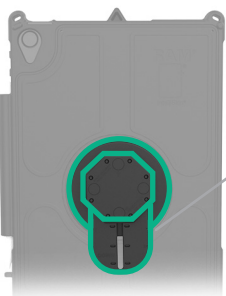

Adjustable Adapter
RAM-GDS-U1AU
GDS® Uni-Conn™ Adjustable Adapter

Enables snap-in compatibility with IntelliSkin® for all device models.

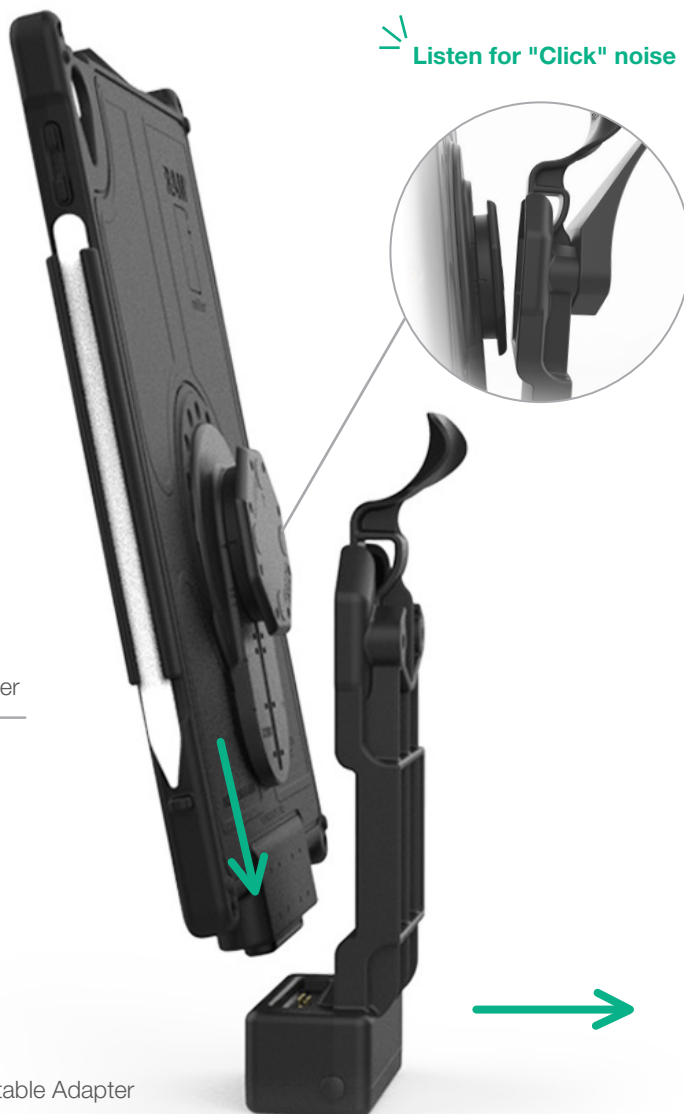

- 1 Set the IntelliSkin®-wrapped device into the bottom connector of the dock.
- 2 Then gently push the device forward until you hear a click.

DEVICE	INTELLISKIN® PART NUMBER	STANDARD GDS® UNI-CONN™ ADAPTER	ADJUSTABLE ADAPTER SETTING POSITION ARROW ORIENTATION	NON-LOCKING SPRING LOADED	LOCKING
iPad 10th Gen	RAM-GDS-SKIN-AP40-NG		#5 ↑	•	
	RAM-GDS-SKIN-AP40-NG-LED		#5 ↑	•	
	RAM-GDS-SKIN-AP40-TCB	•			
	RAM-GDS-SKIN-AP40-TCD	•			



SEEN IN THIS PHOTO:

RAM-HOL-AP36U

RAM® EZ-Roll'r™ Cradle for Apple iPad mini 6

RAM-B-407-C-202U

RAM® Tough-Wedge™ with Double Socket Arm and Round Plate

LATEST MODELS

iPad mini 6

RAM® Mounts offers a wide range of holders for the iPad mini 6, including the formfitting RAM® EZ-Roll'r™ cradle, the RAM® Tab-Tite™ holder, and the RAM® X-Grip® for cased iPad mini 6's.



RAM-HOL-AP36U
RAM® EZ-Roll'r™ Cradle
for Apple iPad mini 6

**Mounting Patterns
Compatible with RAM®
Round Ball Bases Allowing
for Near-infinite Adjustability**

**Made of High-Strength
Composites for
Durability**



RAM-HOL-UN8BU
RAM® X-Grip® Universal
Holder for 7"-8" Tablets with
B Size 1" Ball

SKUS	MOUNT NAME
RAM-HOL-AP36U	RAM® EZ-Roll'r™ Cradle for Apple iPad mini 6
RAM-HOL-UN8BU	RAM® X-Grip® Universal Holder for 7"-8" Tablets with B Size 1" Ball
RAM-HOL-UN8BCU	RAM® X-Grip® Universal Holder for 7"-8" Tablets with C Size 1.5" Ball
RAM-HOL-TAB12U	RAM® Tab-Tite™ Universal Spring Loaded Holder for 8" Tablets with Case
RAM-HOL-TABL12U	RAM® Tab-Lock™ Universal Spring Loaded Holder for 8" Tablets with Case
RAM-HOL-TAB2U	RAM® Tab-Tite™ Spring Loaded Holder for 7" Tablets
RAM-HOL-TABL2U	RAM® Tab-Lock™ Spring Loaded Holder for 7" Tablets

IntelliSkin® for iPad mini 6

Take your iPad's efficiency to the next level with an IntelliSkin®. This device case features an integrated USB-C connector with external pogo pads, unlocking the GDS® Ecosystem™ of vehicle docks, desktop docks, peripheral devices, and ergonomic accessories.

IntelliSkin® Next Gen

Features



IntelliSkin® Thin-Case™

Features



2-PIECE ENCLOSURE
Ensures a reliable and protected connection, providing a seamless fit



ULTRA SLIM DESIGN
A low profile solution that maintains durability in a variety of environments



POLYCARBONATE HARD PLASTIC SHELL
Prevents flex at the connection point between case and device



TWO DISTINCT CONNECTION OPTIONS



Rear Pogo Pads
compatible with all Uni-Conn™ powered docks, pg. 9

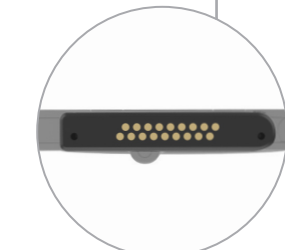

D Shape™ Bottom Connector
compatible with GDS® Ecosystem™, ideal for vehicle and desktop docks

Built-in hand strap connection point
*Accessory sold separately



Rear Pogo Pads



RAM-GDS-SKIN-AP36-TCB
IntelliSkin® Thin Case™ for Apple iPad Pro 12.9 3rd-6th Gen



D Shape™ Bottom Connector



RAM-GDS-SKIN-AP36-TCD
IntelliSkin® Thin Case™ for Apple iPad Pro 12.9 3rd-6th Gen

LATEST MODELS

GDS® Vehicle Dock for iPad mini 6

The GDS® Vehicle Dock is a rugged, modular frame for IntelliSkin®-wrapped devices that are highly customizable to your business needs. These docks are key to the GDS® Reach™ experience—standardized charging, data transfer, and simplified scaling.

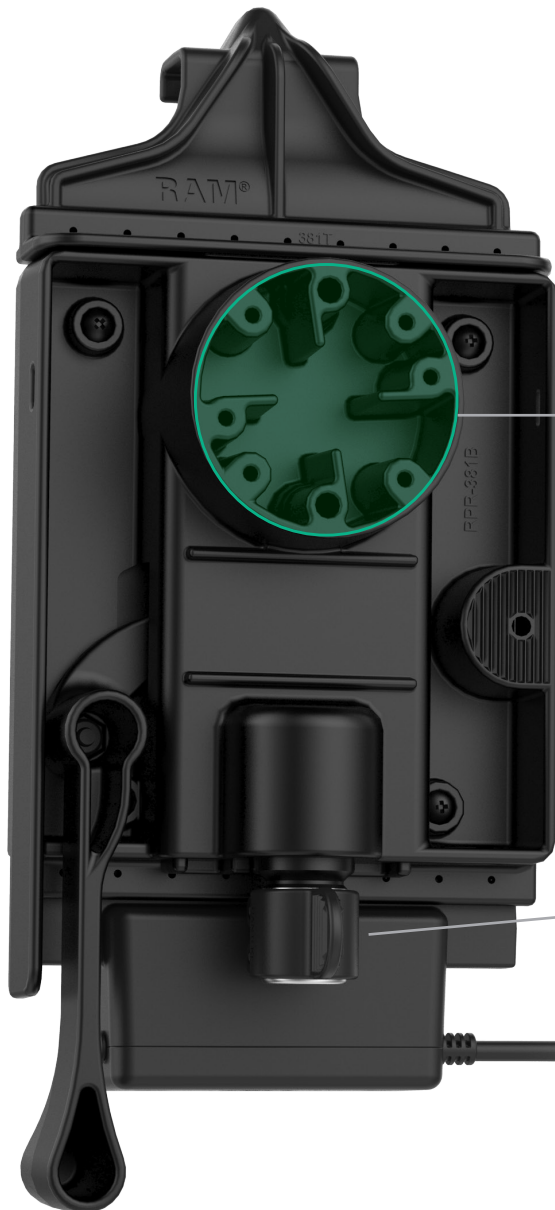

Double Delta Alignment Point Ensures Consistent Connection



USB-C Connection Supports Power delivery

AMPS Mounting Pattern

User-friendly Lever for Easy, Quick Release of Tablet



Keyed Lock for Theft Deterrence

RAM-GDS-DOCKL-V10-OMT3U

GDS® Vehicle Dock for iPad mini 6 with IntelliSkin®

 Listen for "Click" noise

GDS® Uni-Conn™ Docks for iPad mini 6

The GDS® Uni-Conn™ is a universal snap-in docking system. All that is needed is an attachable button adapter and an IntelliSkin® protective case to enable this revolutionary docking station—eliminating the hassle of costly device upgrades. When considering your next device upgrade, there truly is only One Dock to Connect Them All™.

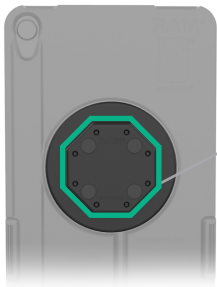

Standard Adapter
RAM-GDS-U1U
GDS® Uni-Conn™ Adapter

Enables snap-in compatibility with IntelliSkin® for newer device models.

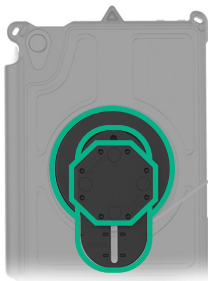

Adjustable Adapter
RAM-GDS-U1AU
GDS® Uni-Conn™ Adjustable Adapter

Enables snap-in compatibility with IntelliSkin® for all device models.

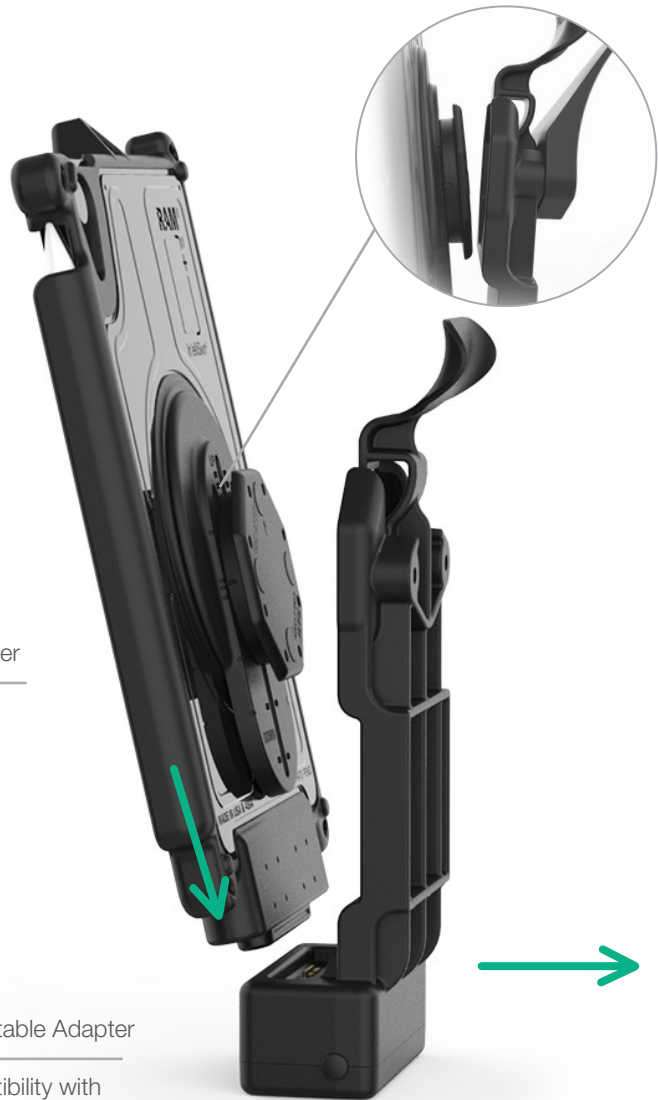

- 1** Set the IntelliSkin®-wrapped device into the bottom connector of the dock.
- 2** Then gently push the device forward until you hear a click.

DEVICE	INTELLISKIN® PART NUMBER	STANDARD GDS® UNI-CONN™ ADAPTER	ADJUSTABLE ADAPTER SETTING POSITION ARROW ORIENTATION	NON-LOCKING SPRING LOADED	LOCKING
iPad mini 6	RAM-GDS-SKIN-AP36-NG		#1 ↑		•
	RAM-GDS-SKIN-AP36-TCB	•			
	RAM-GDS-SKIN-AP36-TCD	•			



SEEN IN THIS PHOTO:

RAM-B-166-AP-MAGU

RAM® Twist-Lock™ Suction Cup Mount for Apple MagSafe®

LATEST MODELS

Apple MagSafe® Adapter

Take advantage of your device's MagSafe® charging capabilities with RAM® Ball Adapter for Apple MagSafe® Charger. Installation is simple, press the magnetic disk into the ball adapter's custom molded cap. This solution is intended for on-road, closed-cockpit vehicles and works best when paired with any B size mounting components.



RAM-B-166-AP-MAGU
RAM® Twist-Lock™ Suction Cup Mount



RAM-B-378-AP-MAGU
RAM® Flex Adhesive Double Ball Mount



RAP-B-202-AP-MAGU
RAM® Ball Adapter
*Recommended only for
light duty and/or closed
cockpit environments



RAP-B-102-AP-MAGU
RAM® Drill-Down Mount



RAP-B-299-4-AP-MAGU
RAM® Stubby™ Cup Holder Mount



RAP-SB-180-AP-MAGU
RAM® Lil Buddy™ Adhesive Dash Mount

Build Your Custom iPhone Mount

Choose from a wide selection of bases to attach your iPhone to your car, boat, bike, motorcycle, and much more. All RAM® iPhone holders—including the popular RAM® X-Grip®, RAM® Quick-Grip™, and form-fit holders – provide access to your device’s ports and buttons. With over 4,000 components on our website, what’s shown here isn’t even close to everything we offer!



1

Choose a Holder

RAM® offers a wide selection of holders for your specific device

2

Choose an Arm

Select an arm based on your desired length and placement

3

Choose a Base

Select from a variety of bases to secure your device where you need it



Vibration damping



Double ball and socket technology allows for near-infinite adjustability of your RAM® mounting system



Highly adjustable

1 Choose a Holder



RAM-HOL-AP39BU
RAM® Form-Fit Holder for iPhone 13 Pro Max, 14 Plus & Pro Max with Ball



RAM-HOL-UN7BU
RAM® X-Grip® Universal Phone Holder with Ball



RAM-HOL-UN10BU
RAM® X-Grip® Large Phone Holder with Ball



RAM-HOL-PD3-238AU
RAM® Quick-Grip™ Universal Phone Holder with Ball



RAM-HOL-UN15WBU
RAM® Quick-Grip™ Holder with Ball for Apple MagSafe®, fits entire iPhone 12 Series



RAP-B-202-AP-MAGU
RAM® Ball Adapter for Apple MagSafe

2 Choose a Double Socket Arm



RAM-B-201U-A
Short Arm



RAM-B-201U
Medium Arm



RAM-B-201U-C
Long Arm

For holders with a ball



RAM-B-103-A-238U
Short Arm



RAM-B-103-238U
Medium Arm



RAM-B-103-C-238U
Long Arm

For holders without a ball

3 Choose a Base



RAM-B-202U
Drill-Down Base



RAM-B-400U
RAM® Tough-Claw™



RAP-B-354U-TRA1
RAM® Track Ball™



RAM-B-MAG66U
RAM® Tough-Mag™



RAM-B-108BU
Hose Clamp Base



RAM-B-247U-3
Square Post
Clamp Base

Car/Truck Mounts



RAM-B-166U
Windshield Mount



RAM-B-138U
RAM® Double Ball Drill-Down
Mount with Diamond Plate



RAP-B-299-4-238U
Cup Holder Mount



RAP-B-378-238U
Adhesive Mount

Motorcycle Mounts



RAM-B-149ZU-A
U-Bolt Handlebar Mount



RAM-B-174U
Brake/Clutch Reservoir Mount



RAM-B-176U
Fork Stem Mount



RAM-B-408-75-1-A-238U
RAM® Torque™ Handlebar Mount

SEEN IN THIS PHOTO:

RAM-HOL-PD4-400-1U

RAM® Quick-Grip® XL Phone Mount with Low-Profile Tough-Claw™



LATEST MODELS

RAM® Low Profile Mounts

Modified versions of the RAM® X-Grip® make it possible to create low-profile phone mounts designed for handlebars and other rails. Utilizing the patented RAM® Pin-Lock™ and RAM® Snap-Link™ technologies, the RAM® X-Grip® is able to sit as low as it can while attached to a RAM® Tough-Claw™, or the new RAM® Tough-Strap™. Each low-profile mount is available for standard-size iPhones and larger iPhones like the Pro Max models.

RAP-460-UN7 & RAP-460-UN10U
RAM® Tough-Strap™
and RAM® X-Grip®,
 easily rotate with the
 turn of a single knob

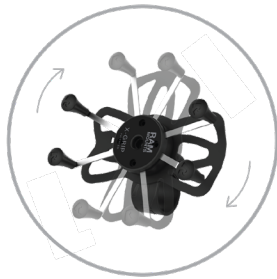

RAP-460-UN7 & RAP-460-UN10U
Quick Release-
No Tools Required



RAP-460-UN10U
 RAM® X-Grip® Large Phone Mount with
 RAM® Tough-Strap™ Handlebar Base

PART NUMBER	MOUNT NAME
RAP-460-UN7U	RAM® X-Grip® Phone Mount with RAM® Tough-Strap™ Handlebar Base
RAP-460-UN10U	RAM® X-Grip® Large Phone Mount with RAM® Tough-Strap™ Handlebar Base
RAP-460Z-UN7U	RAM® X-Grip® Phone Mount with Low Profile Zip Tie Handlebar Base
RAP-460Z-UN10U	RAM® X-Grip® Large Phone Mount with Low Profile Zip Tie Handlebar Base
RAM-HOL-UN7-400-2U	RAM® X-Grip® Phone Mount with Low-Profile RAM® Tough-Claw™
RAM-HOL-UN10-400-2U	RAM® X-Grip® Large Phone Mount with Low-Profile RAM® Tough-Claw™
RAM-HOL-UN7-400U	RAM® X-Grip® Phone Mount with RAM® Snap-Link™ Tough-Claw™
RAM-HOL-UN10-400U	RAM® X-Grip® Large Phone Mount with RAM® Snap-Link™ Tough-Claw™
RAM-HOL-PD4-400-1U	RAM® Quick-Grip® XL Phone Mount with Low-Profile RAM® Tough-Claw™

SEEN IN THIS PHOTO:

RAM-101U-247-3

RAM® 3" Square Post Clamp Mount
with Round AMPS Plate

RAM-GDS-DOCKL-V3CU

GDS® Locking Vehicle Phone Dock
with USB Type-C 3.1 for IntelliSkin®



FEATURES



TOOLLESS INSTALL

For convenient transfer and removal of base



DOUBLE BALL & SOCKET

Technology allows for near-infinite adjustability for your RAM® mounting system



HIGHLY ADJUSTABLE

LATEST MODELS

RAM® Double Ball Mounts for iPads

RAM® double ball mounts and socket arms allow for near-infinite adjustability while also providing shock and vibration damping in several different applications. We've done all the work in determining which turnkey kits are available for a seamless shopping experience. Just tell us your device and vehicle and we'll have a solution ready for you.



Highly adjustable

RAM-101U-247-3

RAM® 3" Square Post Clamp Mount with Round AMPS Plate



RAP-401-202U

RAM® Tough-Claw™ Large Clamp Double Ball Mount with Round Plate



RAM-101-B-225B2U

RAM® Universal Backing Plate Mount



RAM-316-HD-18-202U

RAM® Pod HD™ Vehicle Mount with 18" Aluminum Rod and Round Plate

SEEN IN THIS PHOTO:

RAM-HOL-UN9U

RAM® X-Grip® Universal Holder for
9"-11" Tablets

RAM-VB-196-DB2

RAM® No-Drill™ Universal Vehicle
Floor Mount with Double Ball Mount



LATEST MODELS

RAM® No-Drill™ Mounts

Available for a wide variety of vehicle makes, models, and years, RAM® No-Drill™ mounts are constructed from high-quality steel. Each base attaches using existing seat bolts on the passenger side and is designed to fit your specific vehicle. Create the ultimate mobile workstation with the RAM® No-Drill™ as your platform.

Custom RAM® No-Drill™ mounting base offers a low profile in-vehicle solution



Universal adjustable base accommodates a wide range of vehicles



Ball and socket mounting system offers shock and vibration damping

RAM-VB-196-DB2
RAM® No-Drill™ Universal Vehicle Floor Mount with Double Ball Mount



RAM-VB-178A-DB2
RAM® No-Drill™ Ball Mount for '12-24 RAM 2500-5500 + More



RAM-VB-203-DB2
RAM® No-Drill™ Ball Mount for '19-24 Chevy Silverado + More



RAM-VB-195-DB2
RAM® No-Drill™ Ball Mount for '15-24 Ford F-150, '17-24 F-250 + More

ACCESSORIES

iPad + Keyboard Solutions

Replace your legacy laptops with all-in-one Apple + RAM® Mounts with GDS® Keyboard™ mounting options. Integrate IntelliSkin® with GDS® Tech™ to create a full ecosystem, whether you are mounting in a vehicle with the RAM® Tele-Pole™ and Swing Arm System, or anywhere else using the display bracket option. Pair with any GDS® Keyboard™ and charging harness to connect your ecosystem inside any vehicle. The rugged pogo contacts in GDS® Technology™ offer a universal charging platform for any device wrapped in IntelliSkin®, eliminating the need to plug in a device every time you enter the vehicle, and making device refreshes a quick and inexpensive process.



Full 360-degree rotation and additional RAM® socket arm for ideal placement of multiple devices such as a keyboard + tablet

RAM-VP-SW2F-89

RAM® Tele-Pole™ with 8" & 9" Poles and Double Ball Mount



Double ball and socket technology allows for near-infinite adjustability of your RAM® mounting system



Absorbs shock and vibration while remaining highly adjustable



Keyboard Mounting Options

RAM® double socket arm system provides flexibility for all kinds of mounting solutions.

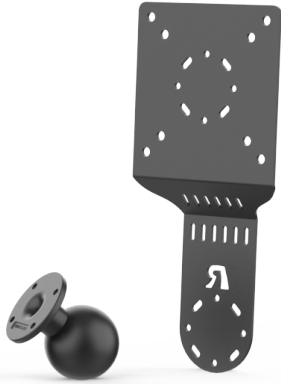

RAM-D-254U + RAM-DIS-103-1AU

D Size 2.25" Ball Mounts Can Support any iPad with Keyboard Using Display Bracket



SEEN IN THIS PHOTO:

RAM-GDS-SKIN-AP32-NG

IntelliSkin® Next Gen for Apple iPad Air 4 & iPad Pro 11" 1st-3rd Gen

RAM-GDS-DOCKL-AP32CD2U

Locking GDS® Tough-Dock™ + Dual USB for iPad Air 4 & iPad Pro 11"

RAM-KB2-USB

GDS® Keyboard™ with Track Pad

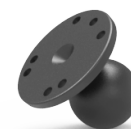

RAM-202U

C Size 1.5" Ball Mounts Can Support any iPad or Keyboard

Temperature Control Products

An empty housing module is located at the back of your dock, allowing you to upgrade your mounting solution at any time. This housing can accommodate various temperature modules provided by RAM® Mounts. Easily install either the RAM® Vent-Temp™, which connects to your vehicle's A/C vents or the RAM® Temp-Right™, which provides regulated heat in extremely cold environments. **Contact your RAM® Mounts representative to ensure compatibility with your solution.**

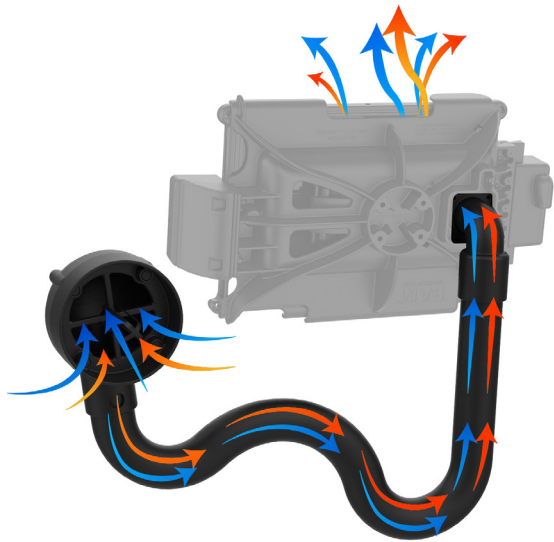

RAM® VENT-TEMP™ BACK NOZZLE ATTACHMENT

Hot or cold air from your vehicle's air system enters through the RAM® Temp-Right™ nozzle, travels through the flexible tube, and exits behind the docked tablet.

RAM-VENT1-RCT-50U
RAM® Vent-Temp™ with
Back Dock Connection for
Rectangular Vents

RAM-VENT1-RND-50U
RAM® Vent-Temp™ with Back
Dock Connection for Round
Vents



RAM® VENT-TEMP™ FRONT NOZZLE ATTACHMENT

Hot or cold air from your vehicle's air system enters through the RAM® Temp-Right™ nozzle, travels through the flexible tube, and exits in front of the docked tablet.

RAM-VENT2-RCT-50U
RAM® Vent-Temp™ with
Front Dock Connection for
Rectangular Vents

RAM-VENT2-RND-50U
RAM® Vent-Temp™ with Front
Dock Connection for Round
Vents

FEATURES



Vent cover attaches directly to circular vents using zip ties

Hose attachment includes built-in magnets for easy break-away when not in-use

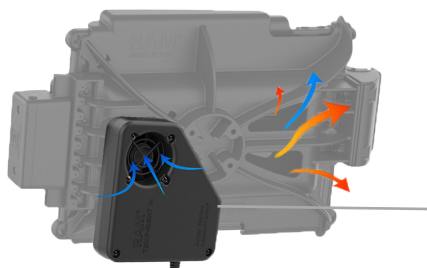

The integrated thermistor regulates temperature to avoid overheating the device

RAM® TEMP-RIGHT™

The RAM® Temp-Right™ heater module regulates device temperatures to maintain functionality in extremely cold environments and contains integrated 11-16VDC hardware charger. Cabin air gets sucked through RAM® Temp-Right™ fan and through the module, heating the air up to the right temperature needed for tablet functionality.

RAM-DOCK-HEATER1-BU
RAM® Temp-Right™ Dock Heating
Module for GDS® Tough-Dock™

SEEN IN THESE PHOTOS:

RAM-VENT1-RCT-50U

RAM® Vent-Temp™ with Back Dock Connection for Rectangular Vents

RAM-GDS-DOCKL-AP32CPU

Locking GDS® Tough-Dock™ for Apple iPad 10th Gen, Air 5 & Pro 11"

RAM-DOCK-HEATER1-BU

RAM® Temp-Right™ Dock Heating Module for GDS® Tough-Dock™

WATCH VIDEO

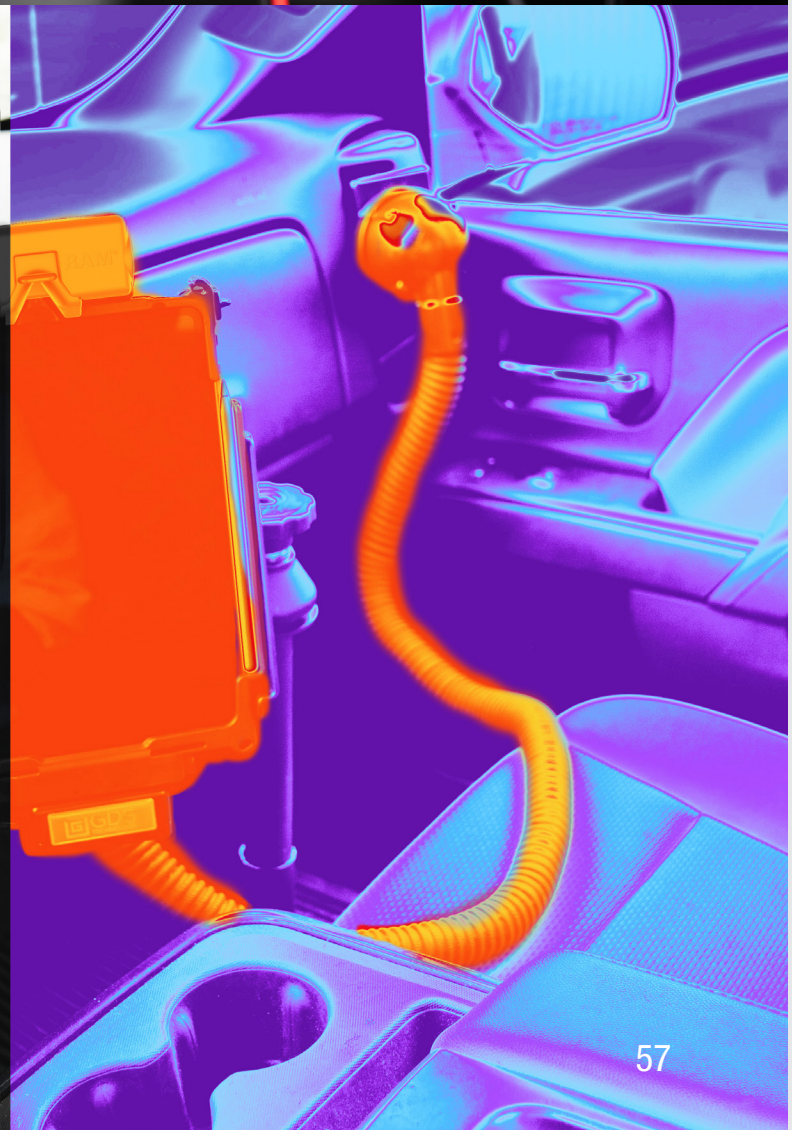

SEEN IN THIS PHOTO:

RAM-HOL-PD4-462B

RAM® Quick-Grip® XL Phone Holder
with Vibe-Safe™ Adapter & Ball



Disclaimer: A reduction in vibration does not guarantee full protection of device. External immeasurable factors may cause damage to phones, cameras, and other devices while mounted in the RAM® Vibe-Safe™. National Products, Inc does not assume responsibility or liability for any such personal injury, death or property damage. RAM® Mounts lifetime warranty is limited to RAM® mounts and components. The warranty does not include any device mounted or attached to a RAM® mount, such as a phone, GPS, camera, computer or other device.

ACCESSORIES

RAM® Vibe-Safe™

The RAM® Vibe-Safe™ is a new vibration-damping accessory from RAM® Mounts. This innovative accessory features damping technology that effectively absorbs and dissipates vibrations across a wide range of frequencies. Built with versatility in mind, the RAM® Vibe-Safe™ is the perfect addition to mounting solutions that span a variety of industries, including Powersports.

RAM-HOL-UN10B-462

RAM® X-Grip® Large Phone Holder with Ball & Vibe-Safe™ Adapter



PART NUMBER	MOUNT NAME
RAP-462NPT	RAM® Vibe-Safe™ with NPT Adapter for 2-Hole Holders
RAP-400-462NPT	RAM® Tough-Claw™ Small Clamp Base with Vibe-Safe™ Adapter
RAM-HOL-UN7B-462	RAM® X-Grip® Phone Holder with Ball & Vibe-Safe™ Adapter
RAM-HOL-UN10B-462	RAM® X-Grip® Large Phone Holder with Ball & Vibe-Safe™ Adapter
RAM-B-149Z-A-UN7-462	RAM® X-Grip® Phone Mount with Vibe-Safe™ & U-Bolt Base - Short
RAM-HOL-PD4-462B	RAM® Quick-Grip™ XL Phone Holder with Vibe-Safe™ Adapter & Ball
RAM-HOL-UN'0-462-400	RAM® X-Grip® Large Phone Mount with Vibe-Safe™ & Large Tough-Claw™
RAM-B-176-A-UN10-462	RAM® X-Grip® Large Phone Mount with Vibe-Safe™ & Fork Stem Base - Short
RAM-B-174-UN10-462	RAM® X-Grip® Large Phone Mount with Vibe-Safe™ & Reservoir Base
RAM-B-149Z-A-PD4-462	RAM® Quick-Grip™ XL Phone Mount with Vibe-Safe™ & U-Bolt Base - Short
RAM-B-149Z-A-UN10-462	RAM® X-Grip® Large Phone Mount with Vibe-Safe™ & U-Bolt Base - Short



SEEN IN THIS PHOTO:

RAM-HS2U

RAM® Universal Hand-Stand™ for 9-13" Tablets

ACCESSORIES

RAM® Universal Hand-Stand™

The RAM® Universal Hand-Stand™ is a versatile ergonomic accessory that doesn't require a certain case or permanent adhesion. The elastic tether easily wraps around the corner of the tablet and maintains a secure hold for peace of mind. The integrated two-in-one kickstand and hand strap fit a wide range of hand sizes, including gloved hands. Stay mobile with this unique, universal accessory.

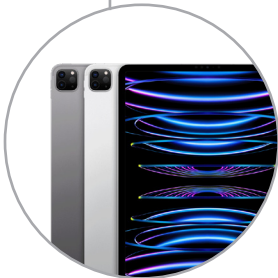

Fits all iPads with or without case

RAM-HS2U
RAM® Universal Hand-Stand® for 9"-13" Tablets

Two-in-one kickstand and hand strap that can rotate between portrait and landscape mode



For iPad mini Series



RAM-HS1U
Standard



RAM-HS1MU
Magnetic

For All Other iPads



RAM-HS2U
Standard



RAM-HS2MU
Magnetic

INDUSTRIES

Accessibility Solutions

RAM® Mounts' unique design approach enables us to create innovative and intuitive solutions for those with limited mobility. Wheelchairs feature several locations for mounting solutions, including the armrest, seat track, and leg rails. Explore our most popular solutions below or reach out to work with one of our product experts to build your custom solution from our catalog of over 4,000 components.



RAP-AAPR-WCT-114P-18-UN9U
RAM® X-Grip® Wheelchair Seat Track Mount for 9"-11" Tablets



RAP-400-18-B-UN8
RAM® X-Grip® Wheelchair Leg Rail Mount for 7"-8" Tablets



RAM-B-238-WCT-2-UN7
RAM® X-Grip® Phone Mount for Wheelchair Armrests



RAM-AAPR-WCT-419-UN7U
RAM® Phone Mount for Wheelchair Armrests with Quick Release & Swivel

SEEN IN THIS PHOTO:

RAM-B-201-201U-C

RAM® Double Socket Arm Adapter with
Medium & Long Arms- B Size

RAM-B-238-WCT

RAM® Universal Wheelchair Ball Base- B Size

RAM-HOL-PD4-238AU

RAM® Quick-Grip™ XL Phone Holder with Ball



COMPATIBILITY

GDS® & IntelliSkin™ Docks

All docks have USB Type-C compatible power charging



iPad 10th Generation and iPad Air 5 and iPad Pro 11" 1st-4th Generation

GDS® Tough-Docks™	🔑	🌀	🔌	🔌
RAM-GDS-DOCK-AP32CPU	-	-	USB Type-C 2.0	-
RAM-GDS-DOCKKL-AP32CPU	Key-Locking	-	USB Type-C 2.0	-
RAM-GDS-DOCKKF-AP32CPU	-	Cooling Fan	USB Type-C 2.0	-
RAM-GDS-DOCKLKF-AP32CPU	Key-Locking	Cooling Fan	USB Type-C 2.0	-
RAM-GDS-DOCK-AP32CU	-	-	USB Type-C 3.1	-
RAM-GDS-DOCKKL-AP32CU	Key-Locking	-	USB Type-C 3.1	-
RAM-GDS-DOCKKF-AP32CU	-	Cooling Fan	USB Type-C 3.1	-
RAM-GDS-DOCKLKF-AP32CU	Key-Locking	Cooling Fan	USB Type-C 3.1	-
RAM-GDS-DOCK-AP32CDU	-	-	USB Type-C 2.0	Single USB Type-A Port
RAM-GDS-DOCKKL-AP32CDU	Key-Locking	-	USB Type-C 2.0	Single USB Type-A Port
RAM-GDS-DOCK-AP32CD2U	-	-	USB Type-C 2.0	Dual USB Type-A Ports
RAM-GDS-DOCKKL-AP32CD2U	Key-Locking	-	USB Type-C 2.0	Dual USB Type-A Ports

IntelliSkin® for 10th Gen



RAM-GDS-SKIN-AP40-NG

IntelliSkins® for Air 5 And Pro 11"



RAM-GDS-SKIN-AP32-NG

RAM-GDS-SKIN-AP32-NG-LED LED Light





iPad Pro 12.9" 3rd-6th Generation

GDS® Tough-Docks™	Key-Locking	Cooling Fan	Power	USB
RAM-GDS-DOCK-AP37CPU	—	—	USB Type-C 2.0	—
RAM-GDS-DOCKL-AP37CPU	Key-Locking	—	USB Type-C 2.0	—
RAM-GDS-DOCKF-AP37CPU	—	Cooling Fan	USB Type-C 2.0	—
RAM-GDS-DOCKLF-AP37CPU	Key-Locking	Cooling Fan	USB Type-C 2.0	—
RAM-GDS-DOCK-AP37CD2U	—	—	USB Type-C 2.0	Dual USB Type-A Ports

IntelliSkin®	IntelliSkin®
RAM-GDS-SKIN-AP37-NG	—



iPad mini 6

GDS® Tough-Docks™	Key-Locking	Power	USB
RAM-GDS-DOCKL-V10-OMT3U	Key-Locking	USB Type-C 2.0	—
RAM-GDS-DOCKL-V10-OMT3CDU	Key-Locking	USB Type-C 2.0	Single USB Type-A Ports
RAM-GDS-DOCKL-V10-OMT3CD2U	Key-Locking	USB Type-C 2.0	Dual USB Type-A Ports

IntelliSkin®	IntelliSkin®
RAM-GDS-SKIN-AP36-NG	—



iPhone 15 Series

Vehicle Docks	Key-Locking	Power
RAM-GDS-DOCK-V1CPU	—	USB Type-C 2.0
RAM-GDS-DOCKL-V3CPU	Key-Locking	USB Type-C 2.0
RAM-GDS-DOCK-V1CU	—	USB Type-C 3.1
RAM-GDS-DOCKL-V3CU	Key-Locking	USB Type-C 3.1

COMPATIBILITY

iPhone & iPad Holders

Model	RAM® Form-Fit	RAM® X-Grip®	RAM® Quick-Grip™
iPhone X	RAM-HOL-AP25U	RAM-HOL-UN7BU	RAM-HOL-PD3-238U
iPhone Xr	RAM-HOL-AP26U	RAM-HOL-UN10BU	RAM-HOL-PD4-238U
iPhone Xs	RAM-HOL-AP25U	RAM-HOL-UN7BU	RAM-HOL-PD3-238U
iPhone Xs Max	RAM-HOL-AP19U	RAM-HOL-UN10BU	RAM-HOL-PD4-238U
iPhone 11	RAM-HOL-AP28U	RAM-HOL-UN10BU	RAM-HOL-PD4-238U
iPhone 11 Pro	RAM-HOL-AP29U	RAM-HOL-UN10BU	RAM-HOL-PD3-238U
iPhone 11 Pro Max	RAM-HOL-AP30U	RAM-HOL-UN10BU	RAM-HOL-PD4-238U
iPhone 12 & 12 Pro	RAM-HOL-AP33U	RAM-HOL-UN10BU	RAM-HOL-PD4-238U
iPhone 12 mini	RAM-HOL-AP34U	RAM-HOL-UN7BU	RAM-HOL-PD3-238U
iPhone 12 Pro Max	RAM-HOL-AP35U	RAM-HOL-UN10BU	RAM-HOL-PD4-238U
iPhone 13 & 13 Pro	RAM-HOL-AP38U	RAM-HOL-UN10BU	RAM-HOL-PD4-238U
iPhone 13 mini	RAM-HOL-AP34U	RAM-HOL-UN7BU	RAM-HOL-PD3-238U
iPhone 13 Pro Max	RAM-HOL-AP39U	RAM-HOL-UN10BU	RAM-HOL-PD4-238U
iPhone 14 & 14 Pro	RAM-HOL-AP38U	RAM-HOL-UN10BU	RAM-HOL-PD4-238U
iPhone 14 Pro Max	RAM-HOL-AP39U	RAM-HOL-UN10BU	RAM-HOL-PD4-238U
iPhone 14 Plus	RAM-HOL-AP39U	RAM-HOL-UN10BU	RAM-HOL-PD4-238U



Model	RAM® Form-Fit	RAM® X-Grip®	RAM® Tab-Tite™	RAM® Tab-Lock™	IntelliSkin®	GDS® Vehicle Dock
iPad 5 th - 6 th Gen	RAM-HOL-AP17U	RAM-HOL-UN9U	-	with case: RAM-HOL-TABL20U	-	-
iPad 7 th -9 th Gen	RAM-HOL-AP31U	RAM-HOL-UN9U	without case: RAM-HOL-TAB26U with case: RAM-HOL-TAB20U	without case: RAM-HOL-TABL26U with case: RAM-HOL-TABL20U	-	-
iPad Air 3	RAM-HOL-AP22U	RAM-HOL-UN9U	without case: RAM-HOL-TAB26U with case: RAM-HOL-TAB20U	without case: RAM-HOL-TABL26U with case: RAM-HOL-TABL20U	-	-
iPad Air 4	RAM-HOL-AP23U	RAM-HOL-UN9U	without case: RAM-HOL-TAB3U with case: RAM-HOL-TAB17U	without case: RAM-HOL-TABL3U with case: RAM-HOL-TABL17U	RAM-GDS-SKIN-AP32-NG	RAM-GDS-DOCKL-V2-AP8U
iPad Air 5	RAM-HOL-AP23U	RAM-HOL-UN9U	without case: RAM-HOL-TAB3U with case: RAM-HOL-TAB17U	without case: RAM-HOL-TABL3U with case: RAM-HOL-TABL17U	RAM-GDS-SKIN-AP32-NG	RAM-GDS-DOCKL-V2-AP16U
iPad mini 6	RAM-HOL-AP20U	RAM-HOL-UN8BU	without case: RAM-HOL-TAB30U with case: RAM-HOL-TAB29U	without case: RAM-HOL-TABL30U with case: RAM-HOL-TABL29U	RAM-GDS-SKIN-AP27	RAM-GDS-DOCKL-V10-OMT3CD2U RAM-GDS-DOCKL-V10-OMT3CD2U
iPad Pro 11" (1 st -4 th Gen)	RAM-HOL-AP23U	RAM-HOL-UN9U	without case: RAM-HOL-TAB3U with case: RAM-HOL-TAB17U	without case: RAM-HOL-TABL3U with case: RAM-HOL-TABL17U	RAM-GDS-SKIN-AP32-NG	RAM-GDS-DOCKL-V2-AP23U For Vehicle Dock see page 39 & 40
iPad Pro 12.9 (2 nd Gen)	RAM-HOL-AP21U	RAM-HOL-UN11U	-	-	-	-
iPad Pro 12.9 (3 rd - 4 th Gen)	RAM-HOL-AP24U	RAM-HOL-UN11U	-	-	RAM-GDS-SKIN-AP24-A	RAM-GDS-DOCKL-V2-AP24CPU
iPad Pro 12.9 (5 th Gen)	-	RAM-HOL-UN11U	-	-	RAM-GDS-SKIN-AP24-A	RAM-GDS-DOCKL-V2-AP24CPU
iPad Air 11" (M2)	-	RAM-HOL-UN9U	with case: RAM-HOL-TAB20U	with case: RAM-HOL-TABL20U	-	-
iPad Air 13" (M2)	-	RAM-HOL-UN11U	-	-	-	-
iPad Pro 11" (M4)	-	RAM-HOL-UN9U	with case: RAM-HOL-TAB20U	with case: RAM-HOL-TABL20U	-	-
iPad Pro 13" (M4)	-	RAM-HOL-UN11U	-	-	-	-



SEEN IN THIS PHOTO

RAM-GDS-CHARGE-V7B1U

GDS® Modular 10-30V
Hardwire Charger with Female
USB Type-A Connector

COMPATIBILITY

Hardwire Chargers

Maintain a consistent power connection to your fleet of devices with the GDS® Modular Hardwire Chargers. When it comes time to upgrade, avoid any rewiring by simply unplugging the power connector and attaching the new charger components. As part of the GDS® Reach™ enabled by the GDS® Ecosystem™, our solutions work seamlessly to keep devices protected, connected, and charged in nearly any application.



RAM-GDS-CHARGE-V3C-2U
GDS® Modular 10-30V Power Delivery Hardwire Charger with Male USB Type-C



RAM-GDS-CHARGE-V3CH-2U
GDS® Modular 30-64V Power Delivery Hardwire Charger with Male USB Type-C



RAM-GDS-CHARGE-V7CU
GDS® Modular 10-30V Hardwire Charger with Male USB Type-C



RAM-GDS-CHARGE-V8BU
GDS® Modular 30-64V Hardwire Charger with Female USB Type-A Connector

Selecting Your Charger

There are two factors to consider when choosing a charger; the charging requirements of your **device and dock** determined by the type of output connector (column 2 below) and the charging requirements of your **vehicle** determined by the input voltage (column 5 below). Cars, trucks and fuel-burning forklifts generally range from 12V to 24V. Electric forklifts generally range from 36V to 48V.

Contact your RAM® Mounts representative to ensure your power supply is compatible with your solution.

HARDWIRE CHARGERS	Output Connector Type	Power Delivery	Legacy USB	Input Voltage	Output Voltage	Input Cable Length	Output Cable Length
RAM-GDS-CHARGE-V3C-2U	USB-C Male	Yes	Yes	10 - 30 VDC	5 - 15 VDC	2.5M	1M
RAM-GDS-CHARGE-V3CH-2U	USB-C Male	Yes	Yes	30 - 64 VDC	5 - 15 VDC	2.5M	1M
RAM-GDS-CHARGE-V7CU	USB-C Male	No	Yes	10 - 30 VDC	5.42 - 9 VDC	2.5M	1M
RAM-GDS-CHARGE-V8CU	USB-C Male	No	Yes	30 - 64 VDC	5.42 - 9 VDC	2.5M	1M
RAM-GDS-CHARGE-V7B1U	USB-A Female	No	Yes	10 - 30 VDC	5 - 9 VDC	1.2M	200mm
RAM-GDS-CHARGE-V8BU	USB-A Female	No	Yes	30 - 64 VDC	5 - 9 VDC	1.2M	200mm

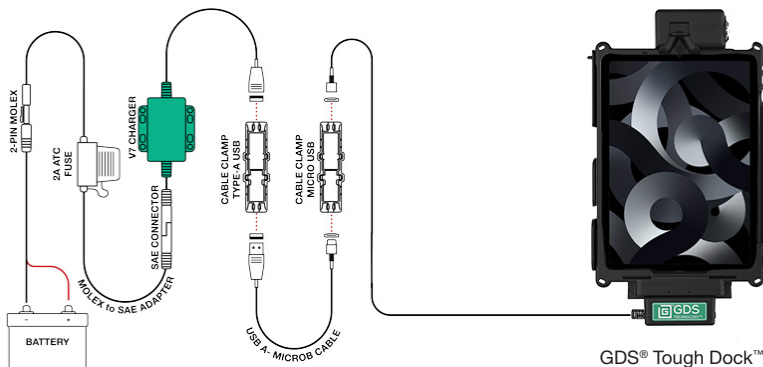

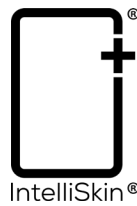

Mount Anything, Anywhere.

rammount.com
1.800.497.7479
sales@rammount.com



GDS®, IntelliSkin®, GDS® Tech™, GDS® Technology™, GDS® Green™, Distinctive "Double Delta" Shape™, One Dock to Connect Them All™, GDS® Uni-Conn™, and GDS® Compatible™ are trademarks or registered trademarks of National Products Inc.

The distinctive D Shape™ of the GDS® connector is a trademark of National Products Inc.

PATENTS AND TRADEMARKS
WWW.RAMMOUNT.COM/IP



RAM® double socket arms with their distinctive Hourglass Shape are recognized globally as a symbol of the reliability, quality, and durability of this line of products. The Hourglass Shape is a registered trademark of National Products Inc.



The distinctive RAM® "X-Grip" product shape is a trademark of National Products Inc.



Look for the highly recognizable "Double Delta" trademark, the symbol of quality and reliability